

75 cents

*hcr*

focus  
on  
communications  
technology . . .

# ham radio

magazine

MAY 1972

● annual  
antenna  
issue



## *this month*

- three-band groundplane 6
- vhf colinear 12
- 1296-MHz Yagi 24
- phased verticals 32
- coax-to-coax coupler 42

# Chew the rag all day or win the contests...

## the CX7A makes them both easier.

There are a couple of different ways to look at signal/one's CX7A. You might compare it to a car.

For the rag-chewer's convenience and ease of operation, it's strictly in the Rolls-Royce category.

For the competitive-minded amateur, it's like driving a Ferrari.

That's because the CX7A was designed with uncompromising quality. With more features than you can imagine. The rig equals a room full of gear, all neatly enclosed in a compact, desk-top unit.

It lets you do things no other rig lets you do. And do all of them better. Sitting at the console of the CX7A you're in command of the amateur radio universe.

Whether you're a Rolls-Royce type or a Ferrari-minded guy.

See the remarkable CX7A at your signal/one dealer's. Or write for a detailed brochure. For \$2,195, you'll be the coolest rag-chewer in town.

Or the hottest competitor.

 **signal/one**

a subsidiary of  
**Computer Measurements, Inc.**  
1645 West 135th Street  
Gardena, California 90249  
Phone: (213) 532-9754



# Why won't Don Wallace listen to anyone else?

W6AM doesn't have to, since he began using our professional quality VHF-FM 2 meter transceiver with exclusive *Astropoint*. The precise and powerful *Astropoint* system actually blocks out all interference. So when one of the nation's number one hams is having a 2-way conversation he won't have unwanted interference.

*Astropoint* is featured on all standard transceivers including the rugged, 12 channel SR-C826M.

It's not only a compact mobile but even fully portable with the addition of a battery pack. And there's a lot more that appeals to Don about the SR-C826M

than just *Astropoint*. All silicon semi-conductors with solid state circuitry. Ten watts of R.F. output power combined with low power consumption. MOSFET R.F. Amplifiers and mixers. And the list of features goes on.

Which is why Don Wallace hasn't been listening to anyone else lately. Not that he's choosy about who he listens to. Just whose equipment he listens on.

For complete specifications and the name of your nearest dealer, write:

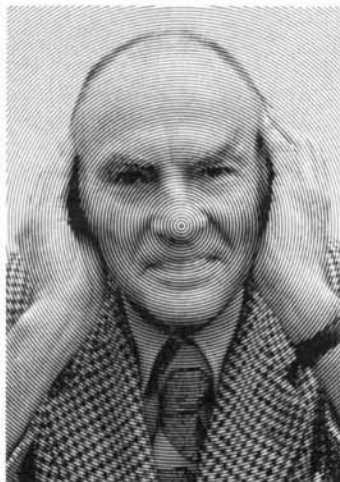

**STANDARD  
COMMUNICATIONS  
CORP.**

639 North Marine Ave.,  
Wilmington, Calif. 90744  
(213) 775-6284





# Rugged Giants

## Tri-Ex Sky Needle Towers

### Give your antennas a big lift!

Regular and  
heavy duty  
towers

This advanced state-of-the-art "Sky Needle" is fast earning its own special place of honor in the ham-communications field. Tri-Ex takes great pride in being the developer and first to build this crank-up, freestanding tubular tower for the amateur. Uniquely eye-pleasing, the slim and graceful "Sky Needle" is a symbol of pride to its owner as well as proof positive that he has the very best in towers. Tri-Ex offers immediate

delivery. Act now! Write for your free brochure, today.

\*Three Hi-Gain 10, 15, 20M long jolns.

\*\*Log-periodic antenna for MARS use 13 to 30 MHz.

MODEL	HEIGHT	
	EXTENDED	NESTED
TM-240	40'	22'
TM-358	58'	22½'
TM-370/370HD	70'	27'
TM-490	90'	28'
TM-5100R	100'	29'



**Tri-Ex TOWER CORPORATION**

7182 RASMUSSEN AVE. VISALIA, CALIF. 93277

May, 1972  
volume 5, number 5



**ham**  
**radio**  
magazine

**staff**

James R. Fisk, W1DTY  
editor

Douglas S. Stivison, WA1KWJ  
assistant editor

Nicholas D. Skeer, K1PSR  
vhf editor

J. Jay O'Brien, W6GDO  
fm editor

Alfred Wilson, W6NIF  
James A. Harvey, WA6IAK  
associate editors

Curt J. Witt  
art director

Wayne T. Pierce, K3SUK  
cover

T. H. Tenney, Jr. W1NLB  
publisher

Hilda M. Wetherbee  
advertising manager

**offices**

Greenville, New Hampshire 03048  
Telephone: 603-878-1441

**ham radio** magazine is  
published monthly by  
Communications Technology, Inc  
Greenville, New Hampshire 03048

Subscription rates, world wide  
one year, \$6.00, three years, \$12.00  
Second class postage  
paid at Greenville, N. H. 03048  
and at additional mailing offices

Foreign subscription agents  
United Kingdom  
Radio Society of Great Britain  
35 Doughty Street, London WC1, England

All European countries  
Eskil Persson, SM5CJP, Frotunagrand 1  
19400 Upplands Vasby, Sweden

African continent  
Holland Radio, 143 Greenway  
Greenside, Johannesburg  
Republic of South Africa

Copyright 1972 by  
Communications Technology, Inc  
Title registered at U. S. Patent Office  
Printed by Wellesley Press, Inc  
Wellesley, Massachusetts 02181, USA

**ham radio** is available to the blind  
and physically handicapped on magnetic tape  
from Science for the Blind  
221 Rock Hill Road, Bala Cynwyd  
Pennsylvania 19440  
Microfilm copies of current  
and back issues are available  
from University Microfilms  
Ann Arbor, Michigan 48103

Postmaster: Please send form 3579 to  
**ham radio** magazine, Greenville  
New Hampshire 03048

# contents

- 6 three-band groundplane**  
Peter Brekken, LA1EI
- 12 nine-element vhf colinear**  
Milton S. Ash, W6RJO
- 19 gamma-loop-fed vertical dipole**  
William I. Orr, W6SAI
- 24 high-performance 1296-MHz Yagi**  
Reed E. Fisher, W2CQH
- 28 versatile swr meter**  
Earnest A. Franke, WA4WDK
- 32 all-band phased-vertical system**  
Ernest S. Chaput, WA7GXO
- 36 small-loop antennas**  
Ervin G. Von Wald, W4YOT
- 42 coax-to-coax antenna coupler**  
E. R. Cook, ZS6BT
- 46 improving mobile loading**  
Stark Totman, W4YB
- 50 measuring coaxial-line loss**  
Milton A. Dexheimer, W2VCI
- 54 antenna potpourri**  
Edward M. Noll, W3FQJ
- 4 a second look**
- 115 flea market**
- 126 advertisers index**
- 66 ham notebook**
- 54 circuits and techniques**
- 70 new products**
- 58 comments**
- 126 reader service**

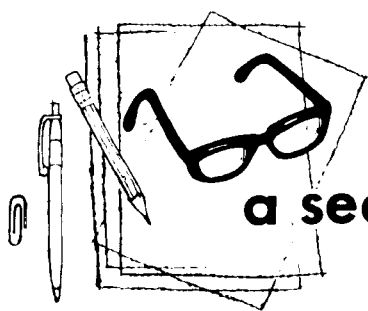

# a second look

by jim  
fisk

**Have you been avoiding** the exam for the Extra Class license because of the code-speed requirement? Below are some hints that might help you over the hump. It should be remembered, however, that no easy way exists for developing code speed and the confidence so necessary in the examination room. Practice is essential—there's no other way.

Many arguments have been advanced for eliminating the code test for amateur radio licenses. Some of them present a pretty good case, but the fact remains that the FCC requires a *20-wpm* code test for amateur Extra Class, and it looks like this requirement will be around for some time to come. So if you sincerely want to earn that Extra Class ticket you'll have to bite the bullet and improve your code speed.

One method for practicing code is with a tape recorder, but many fellows don't have one. Another method, of course, is by copying other amateurs on the air. This method has disadvantages such as signal fading, inconsistent speed and character spacing, and irregular on-the-air time of stations you're trying to copy.

The code-practice transmissions by ARRL's W1AW are excellent sources of perfect, tape-controlled code, which are available to anyone having a shortwave receiver. But here again problems exist. W1AW is limited to the maximum legal power input of 1 kW for amateur stations and is subject to the caprices of propagation conditions, not to mention interference, intentional or otherwise, by other amateur stations.

If you own a general-coverage receiver, you can augment W1AW's code-practice transmissions by copying commercial coastal stations, which are available

around the clock in the high-frequency marine bands of 4, 6, 8, 12, and 16 MHz. These stations handle traffic for ships and are manned by top-notch operators whose job is to get the message through. Therefore, code transmissions from the coastal marine stations are tailored to fit prevailing conditions existing in the radio circuit. This means a reliable source of code practice is available with excellent code at speeds between 10 and 35 wpm. Another advantage is that these stations operate on clear channels, and their frequencies in the hf bands assure consistent communications during most propagation conditions.

The following table lists some of the public-service coastal stations in the 8-MHz marine band that provide excellent code practice. Several stations (WNU for example) transmit taped press items at a steady, interference-free 25 wpm—wonderful for building up your code speed.

Station	frequency (MHz)	power (kW)	location
WSL	8.514	2.5	New York, N. Y.
WSL	8.658	10.0	
WCC	8.586	10.0	Chatham, Mass.
WNU	8.570	2.0	New Orleans, La.
WSC	8.610	20.0	Tuckerton, N. J.
WSC	8.686	2.0	
WPA	8.550	3.0	Pt. Arthur, Tex.
KOK	8.590	10.0	Los Angeles, Cal.
KPH	8.618	10.0	San Francisco, Cal.
KFS	8.558	10.0	San Francisco, Cal.

These are only a few of the stations available as code-practice sources for those who really want to earn the coveted Extra Class amateur license.

Will I see you down on the "basement frequencies?" I hope so.

Jim Fisk, W1DTY  
editor



## Man's favorite sport



Hiking, hunting, fishing. For a lot of people, a lot of fun.

But we know another kind of guy. A ham. He heads for the hills to fish for a rarer species — those elusive, far-away QSO's.

For him, we make the FT-101 transceiver. It puts a new kind of recreation into a recreational vehicle (or the family bus, for that matter).

The FT-101 weighs only 30 pounds. But we didn't waste an ounce. We packed it with 260 watts PEP SSB. 180 watts CW. 80 watts AM. Plus 0.3 micro-

volts receiving sensitivity with a 10 db signal-to-noise ratio. Both 117 AC and 12 VDC power supplies are built in.

The FT-101 includes a noise blanker, to lop off ignition spikes. VOX. 25 and 100 KHz calibrators. A  $\pm 5$  KHz clarifier. A built-in speaker. We even supply the mike.

All of that, and more features, too, which are detailed in a brochure we'll be glad to send you.

Of course, we'll be glad to send you the rig. If you'll send us a check for \$559.95. Then go fishing. From your den, or from your dune buggy. Really, your competition won't have a sporting chance.



### SPECTRONICS WEST

Dept. Q, 1491 E. 28th, Signal Hill, Ca. 90806 / (213) 426-2593

### SPECTRONICS EAST

Dept. Q, Box 1457, Stow, Ohio 44224 / (216) 923-4567

Please send detailed information on all Yaesu products.

Enclosed find \$ \_\_\_\_\_

Please send model(s) \_\_\_\_\_

Name \_\_\_\_\_

Address \_\_\_\_\_

City \_\_\_\_\_ State \_\_\_\_\_ Zip \_\_\_\_\_

All prices F.O.B. Signal Hill, Ca.

Master Charge and BankAmericard accepted. "H5"

# three-band groundplane

Theory and design  
of a simple  
three-band groundplane  
featuring optimized  
20-meter DX performance  
and desktop  
bandswitching

Vertical antennas are popular among those of us who have little space to erect an antenna. The vertical antenna has certain desirable features—and unfortunately, some less desirable ones also. Among its good points, it is usually

non-directional, yet it can be made to give some gain over a horizontal half-wave dipole. Vertical elements can be combined in an array to give a desired gain or radiation pattern, just as you can do with horizontal elements.

## radiation angle

The radiation from wire antennas is polarized in the direction of the wire; thus the vertical antenna gives vertical polarization with the major part of the radiation occurring at a much lower angle than the radiation from a horizontal dipole. Fig. 1 shows the vertical-plane radiation pattern for a horizontal dipole at various heights above ground.\* Because of the reflections from the ground, these patterns are very different from the theoretical free-space pattern shown in fig. 2. The patterns are independent of the length of the dipole, but as the diagrams show, are very dependent on the height above ground.

Thirty to forty feet would frequently be considered a quite acceptable height for a halfwave dipole. On 40 meters this equals about  $\frac{1}{4}$ -wavelength, and we can

*\*The ARRL Antenna Handbook contains a far more complete collection of radiation patterns for horizontal dipoles at heights from  $\frac{1}{8}$  to 2 wavelengths. This book is highly recommended to those interested in further study, construction or experimentation with antennas.*  
editor.

Peter Brekken, LA1EI, Vegmester Kroghs gt. 24B, 7000 Trondheim, Norway



apply **fig. 1A**. From the figure we see that the major part of our precious few watts of rf are radiated straight upwards — into the empty space. Since we are usually not interested in space communication on 40

able amount of the radiation at high angles.

## propagation

It is known that high-frequency radio

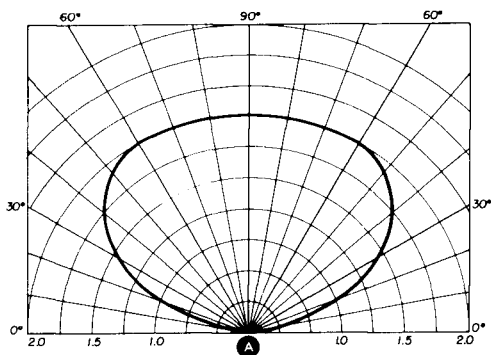

**Antenna at  $\frac{1}{4}$ -wavelength.** Notice large amount of power wasted in straight vertical radiation.

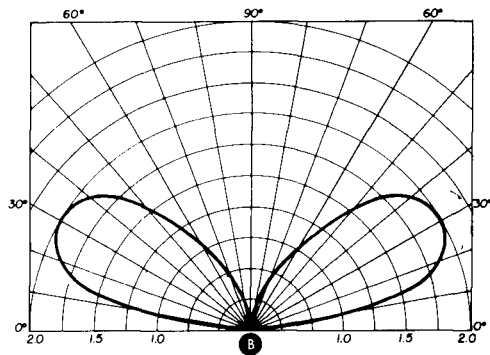

**Antenna at  $\frac{1}{2}$ -wavelength.** Note how the majority of power is transmitted at an angle of  $30^\circ$ .

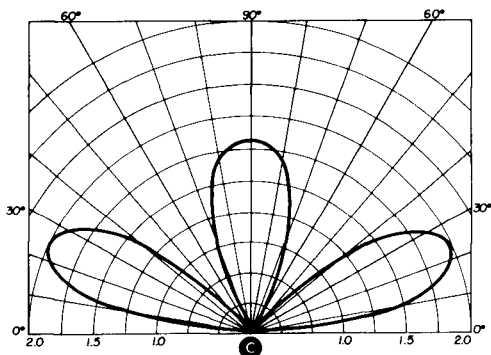

**Antenna at  $\frac{5}{8}$ -wavelength.** At least two-thirds of the available power goes into useful, low angle radiation — but not so low as to be totally absorbed by the earth.

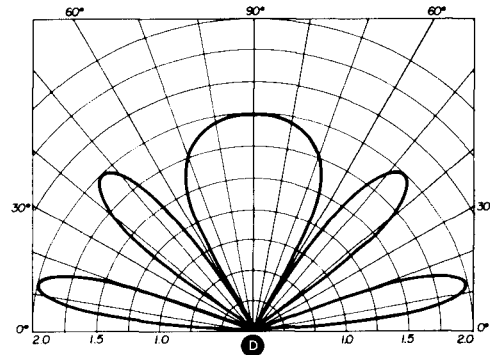

**Antenna at  $1\frac{1}{4}$ -wavelength.** Notice how power is again being wasted in vertical radiation which the ionosphere will not reflect back to earth.

**fig. 1.** Vertical plane radiation patterns from horizontal dipoles at different heights about a perfectly reflecting ground.

meters, this will not make a very efficient antenna. On 20 meters the same height equals  $\frac{1}{2}$ -wavelength, and from **fig. 1B** we can see that the major radiation now occurs at an angle of approximately  $30^\circ$ . At 10 meters, when the height is 1- to  $1\frac{1}{2}$ -wavelengths, the radiation splits into more lobes, and we still have an appreci-

able amount of the radiation at high angles. waves (3 to 30 MHz) are to some extent reflected from the layers of ionized air in the stratosphere, mainly the so-called F2 layer which exists at an altitude of about 150 to 250 miles. When the reflected wave reaches the earth again, it can be received. In this way, distances up to 2500 miles can be covered in one hop. Usually

the wave that reaches the earth is reflected upwards again, and can, under good conditions, make at least three or four hops which will cover distances up to 10,000 miles or more.

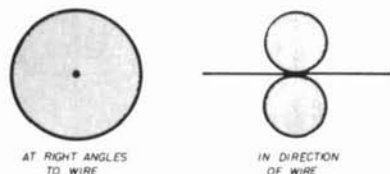

fig. 2. Free-space radiation patterns for a  $\frac{1}{2}$ -wavelength dipole. Compare these patterns with the patterns of fig. 1 to see the effects of ground reflection.

During each hop the wave is attenuated a certain amount. The wave that covers the distance in the smallest possible number of hops, therefore, will give the best signal strength at the receiver. It is easy to see that the antenna which has the lowest radiation angle will cover the greatest distance per hop and consequently should be the best DX antenna. From fig. 3 we can see that some of the vertical antennas have their maximum radiation at angles below  $10^\circ$  which is significantly less than for the horizontal dipoles we have studied.<sup>1, 2</sup>

The properties of an antenna over flat conducting earth can be evaluated by considering the earth as a mirror. The obvious effect of a mirror is to create an image, and the antenna and its image are symmetrical with respect to the reflecting surface. The resulting radiation can be found by considering the antenna and its image as the radiating system. Thus a  $\frac{1}{4}$ -wavelength vertical antenna with its image added equals a vertical  $\frac{1}{2}$ -wavelength dipole. Then it is easy to imagine that the  $\frac{1}{4}$ -wavelength vertical should have the same gain as the half-wave dipole. A  $\frac{5}{8}$ -wavelength vertical corresponds to an extended zepp and should give about 3-dB gain over a half-wave dipole.

### efficiency

Up to now we have not considered that earth has only a finite conductivity.

Our mirror, therefore, is not perfectly reflecting. Some of the energy radiated at the very lowest angles (below  $5^\circ$  or so) will be lost and only used to heat the soil.

One can define a factor of efficiency,  $\eta$ , for an antenna as for other electrical apparatus.

$$\eta = \frac{\text{radiated power}}{\text{input power}} 100\% \approx \frac{R_r I^2}{(R_r + R_{\text{loss}}) I^2} 100\%$$

$$\eta = \frac{R_r}{R_r + R_{\text{loss}}} 100\%$$

Here  $R_r$  is the radiation resistance and  $R_{\text{loss}}$  is the equivalent series loss-resistance.

The half-wave dipole has a radiation resistance  $R_r$  of about 72 ohms. The loss resistance  $R_{\text{loss}}$  is simply the resistance of the antenna wire, which is at most a few ohms. The efficiency, therefore, will be close to 100%.

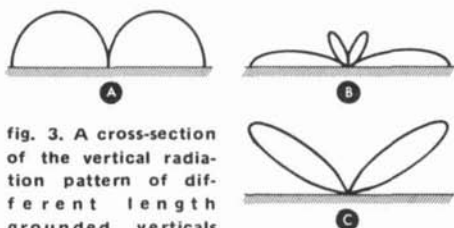

fig. 3. A cross-section of the vertical radiation pattern of different length grounded verticals over perfectly conducting ground. (A) Antenna length is  $\frac{1}{4}$ -wavelength. (B) Antenna length is  $\frac{5}{8}$ -wavelength. Notice the majority of power going into low-angle radiation. (C) Antenna length is one full wavelength.

We have considered the vertical antenna as one half of a dipole. As you might expect, its radiation resistance is one half of the resistance of the corresponding dipole. The radiation resistance of a  $\frac{1}{4}$ -wavelength vertical is about 36 ohms, and a  $\frac{5}{8}$ -wavelength vertical has a radiation resistance in the vicinity of 70 ohms. The loss resistance depends on the conductivity of the soil and is difficult to calculate. It varies with frequency and other factors and can typically be in the order of some tens of ohms.

In order to achieve a reasonably high efficiency, we see from our formula for  $\eta$  that it is important to keep the ground losses small and the radiation resistance high. The radiation resistance can be increased by increasing the antenna length. The loss resistance is somewhat tricky to minimize. Wet soil is a reasonably good conductor, so the wettest point in the garden would seem to be the best point to place a vertical. A well known trick used at broadcast stations is to install a ground net consisting of as long and as many radials as possible, either on the ground or buried a few inches below the surface. Fifteen radials at least 1/8-wavelength long should give a worthwhile improvement.

### the groundplane

The vertical does not necessarily have to be placed on the ground. The ground-plane antennas have an artificial ground-plane usually constructed from radials. The whole structure can then be placed on the roof or at any convenient location so as to get clear of obstacles that might otherwise be screening the radiation. To get the best results there should theoretically be an infinite number of infinitely long radials. However, many people are getting excellent results with the 1/4-wavelength vertical with two to four radials each 1/4-wavelength long. If the ground-plane is at a reasonable height (1/4-wavelength or more) you can expect good results from four radials.

The current and voltage distribution on the radials can be considered to be approximately sinusoidal. The current is maximum at the feedpoint and has its first null a 1/4-wavelength away from the feedpoint. We do not need any wire to carry the current if it is zero so we might as well cut the radial here. To rf, the 1/4-wavelength radials will look like they are of infinite length and have the loss resistance of a 1/4-wavelength wire. It is clear, therefore, that the length of the radials is equally important to good operation as is the length of the vertical element.

The radiation resistance of the 1/4-wave-

length vertical, about 36 ohms, does not give a perfect match to the usual 50- or 75-ohm coaxial cable. Slanting the radials downwards increases the radiation resistance somewhat so that at an angle of approximately 45° a reasonably good match to 50-ohm coax is possible. This is usually very practical when the antenna is mounted on a roof or at the top of a pole.

From what was said before, we know that another way of increasing the resistance would be to increase the antenna length. Increasing it to 5/8-wavelength gives an excellent match to 75-ohm coax. At the same time we get a 3-dB gain over a half-wave dipole. The antenna is not naturally resonant however, so in addition to the ohmic radiation resistance of 75 ohms, the feedpoint impedance has a capacitive reactance of 250 ohms. This reactance can be tuned out by a series coil.

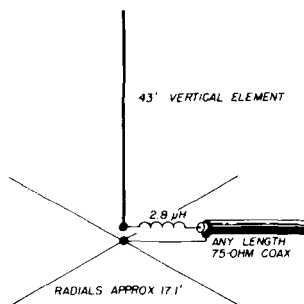

fig. 4. 5/8-wavelength vertical for 20 meters.

### a DX antenna

Let us try and design a 5/8-wavelength antenna for the 20-meter band. The length will be about 43 feet, but this is not very critical. We must use a series coil:

$$L = \frac{X}{2\pi f} = \frac{250}{2\pi(14.3)} = 2.8 \mu\text{H}$$

This would make an excellent one-band DX antenna (fig. 4).

### multiband designs

Many of us would like to use the same

antenna for more than one band. The antenna just described would not work well on 10 and 15 meters. The radiation at the higher angles increases considerably as the antenna length exceeds one wavelength. It could presumably be put to good use at 15 meters, but this is not considered here.

On the lower bands, however, we can get low-angle radiation. If we try to use our 20-meter groundplane on 40 meters, we get a length of about 0.32 wavelength. The gain is about the same as for a half-wave dipole, but with a lower radiation angle. The feedpoint impedance shows a radiation resistance of about 140 ohms and an inductive reactance of 260 ohms. To tune out the reactance we can use a series capacitor of 88 pF. If we use 75-ohm coax the swr will be close to 2:1. This gives a loss of about 0.1 dB in 100 feet of coax, which is of no consequence. However, some transmitters will not tolerate this standing-wave ratio.

On 80 meters the length is 0.16 wavelength. The gain is about 0.5 dB down compared to the halfwave dipole. Radiation resistance is low, about 8 ohms, and the reactive part of the feedpoint impedance is about 280 ohms, capacitive. This necessitates a series coil of 12.7  $\mu$ H. The swr is now very high, 10:1, and with

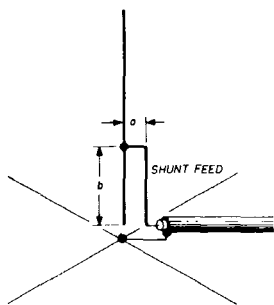

fig. 5. Vertical antenna with gamma match. Suggested dimensions for using the 43-foot antenna on 80 meters would be,  $a=5''$ ,  $b=10'$ .

100 feet of 75-ohm cable, there is a loss of around 1.2 dB. The same length of 50-ohm cable (swr = 6:1) gives a loss of 0.5 dB.

RG8U and many other types of cable have a guaranteed power handling capability of 2000 watts. The power rating is usually limited by the maximum allowable voltage that the line will withstand. Standing waves give increased voltages so that the maximum allowable power is decreased proportionally to the standing-wave ratio. An swr of 6:1 will reduce the maximum power to 1/6, or about 350 watts.

## matching the antenna

Some sort of matching device would

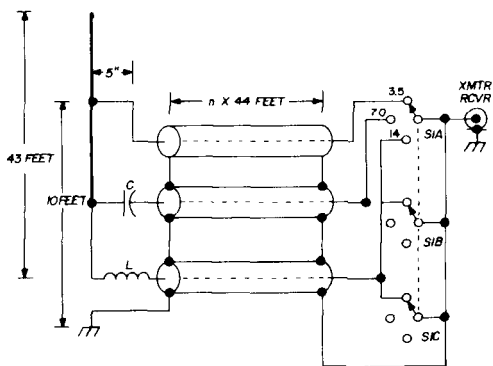

fig. 6. The completed three-band vertical. See table 1 for impedances.

be welcome. A toroidal transformer connected between antenna and feeder could be used.<sup>3</sup> A matching device that would seem to be ideally suited in this case is the shunt-feed or gamma match illustrated in fig. 5. The gamma match can give an impedance step up of up to six times. In addition, it exhibits an inductive reactance which usually is unwanted and troublesome. In our case, however, we can use the inductive reactance to cancel the capacitive reactance of the antenna itself, and at the same time obtain a better impedance match to 50-ohm coax. If there are standing waves on a feeder, you know that the feeder will act as an impedance transformer. By using a series coil, capacitor and gamma match, you can make the feedpoint impedance ohmic. If the impedance presented at the transmitter end of the feeder also is to be ohmic, we will have to

table 1. Feedline impedance of the three-band vertical of fig. 6. Impedances are given for feedlines which are even and odd multiples of 44 feet.

band (MHz)	feedline impedance (ohms)	
	odd	even
3.7	25	100
7.0	140	34
14.0	75	75

use a feeder which is a multiple of an electrical quarter wavelength. In coax cable, a quarter wavelength at 80 meters (3.7 MHz) is approximately 44 feet.

If you use this antenna on 80, 40 and 20 meters with a single feeder, you must use a relay (or a switch) at the base of the antenna to switch in the right matching device for each band. Another possibility is to use separate feeders for each band and perform the switching by a simple rotary switch in the shack.

A suggested layout using the latter principle is shown in fig. 6 for use with feeder lengths that are an odd multiple of 44 feet. The feeders that are not in use are shorted by the switch to minimize the influence from the coil and capacitor for the other bands. If even multiples of 44 feet are used as feeder lengths, you can omit the shorting switches S1B and S1C.

All component values are calculated using approximate methods (especially the dimensions of the 80-meter gamma match), and some cut and try may be necessary to obtain the best swr. Both the step-up ratio and the capacitive reactance of the gamma match increase as the gamma section is made longer. They do not increase in the same proportion; as the length is increased the increase in reactance will be faster than the increase in step-up ratio.

#### references

1. F. E. Terman, "Radio Engineers Handbook," McGraw-Hill, New York, 1943.
2. W. L. Weeks, "Antenna Engineering," McGraw-Hill, New York, 1968.
3. William Orr, W6SAI, and William Sayer, WA6BAN, "Wide-band Bridge Baluns," *ham radio*, December, 1968, page 28.

ham radio

## 2 Rigs in one!

### THE COMCRAFT CTR-144



MADE IN U.S.A.

### The First AM-FM Solid-State Transceiver For Two Meters

No longer is it necessary to choose between AM and FM on two meters. Now you can have both in one compact unit. Join the gang on the new FM repeaters yet still be able to "rag chew" with old friends either AM or FM anywhere in the two meter band.

#### COMPARE THESE FEATURES

##### TRANSMITTER:

- Built-in VFO (Frequency converted for stability)
- AM and FM both crystal and VFO
- Four transmit crystal positions (8 MHz)
- 12 watt input AM and FM
- High level transmitter modulation on AM
- Bandpass coupled transmitter requiring only final tune and load
- Three internal transmit crystal sockets with trimmers for netting
- One transmitter crystal socket on the front panel
- Deviation limiting
- 146.94 MHz crystal included

##### RECEIVER:

- Double conversion
- Crystal controlled first conversion
- MOS FET receiver front-end
- Integrated circuit limiter and discriminator for FM
- Envelope detector and series gate noise clipper for AM
- Built-in squelch for both AM and FM

##### GENERAL:

- Separate transmitter and receiver tuning
- Built-in 115VAC power supply
- Direct 12VDC operation for mobile or portable operation
- Optional portable rechargeable snap-on battery pack available
- "S" Meter also used for transmitter tune up
- Military style glass epoxy circuit boards
- Anodized lettering and front panel
- Baked epoxy finish on the cabinet
- 47 transistors, 22 diodes, 1 integrated circuit
- Dimensions: 10 1/4" W x 6 1/4" H x 7 1/2" D

Warranty—90 Days Parts and Labor

The CTR-144 is available at your  
DEALER or order FACTORY DIRECT  
\$459.95



COMCRAFT COMPANY  
P.O. BOX 266—GOLETA, CALIF. 93017

Write for more information or  
use READER SERVICE

# nine-element colinear antenna for two meters

The colinear antenna  
is becoming popular  
for vhf work —  
this version  
has appreciable gain  
and features  
some novel  
construction ideas

The vertically polarized colinear antenna described in this article is constructed entirely of lightweight aluminum tubing including dipole elements, stubs, and mast. The stubs are integral with the dipoles, being of the same type tubing. This design is in contrast to that of most colinear antennas described in the literature, which use wire elements and stubs supported by nonconductive structures.

The antenna uses nine dipoles, with the metal mast spaced  $\frac{1}{4}$  wavelength from the dipoles. Experimental data indicates that this array provides about 9-dB gain over an isotropic radiator in the horizontal direction. The metal mast apparently acts as a set of individual reflectors for each dipole.

Included are data on construction, tuning, adjustment, and a theoretical discussion on radiation patterns. Also presented are some test results from experiments using a 1/9-scale model antenna to verify certain assumptions.

As with all amateur antenna designs, the data supplied here is subject to modification based on a rigorous theoretical analysis and tests conducted in a laboratory environment. However, the subject is presented as an amateur antenna design, with supporting data based on amateur experiments. The antenna performs as intended, which was

Milton Ash, W6RJO

the objective of the entire project.

## evolution of the colinear

The colinear antenna evolved from the early Franklin array of the 1920's. The Franklin used wire elements, with or without parasitic reflectors, and was suspended from hundred-foot-high towers. It was originally used for commercial point-to-point long-haul circuits on medium-high frequencies. As higher frequencies came into use, scaled-down versions were used for airborne search radars. As an example, a WW II X-band radar antenna, consisting of some 200 colinear dipoles, was mounted on one side of a horizontally-oriented waveguide. The individual feeds consisted of one leg of each dipole protruding into the guide. A bellows arrangement mechanically oscillated the opposite side of the guide, which varied the phasing of the feed system. The entire array was mounted inside an airfoil under the fuselage of the B-29 bomber. This configuration yielded a windshield-wiper-like oscillating scan, about 60 degrees wide, for scope viewing. The plane of the resulting very thin beaver-tail-shaped beam was perpendicular to the aircraft wings.

## two-meter colinear

For the two-meter amateur band I wanted a vertically polarized antenna with the following features:

1. No moving parts, thus avoiding rotator problems.
2. Inexpensive, readily available materials.
3. Appreciable gain, with a pattern that would cover the local Los Angeles area, which is bounded by the sea to the West.

The answer appeared to be a multi-element colinear made of scrap aluminum, mast and all. One 35-40 foot 2½-inch-diameter mast and six 12-foot sections of 3/8-inch tubing (i. e., electrical conduit) are the main items to be acquired.

## construction

As shown in fig. 1, the antenna is made of ½-wave dipoles separated by ¼-wave stubs. The dummy stubs, as explained later, have no effect on the antenna electrical characteristics, but are

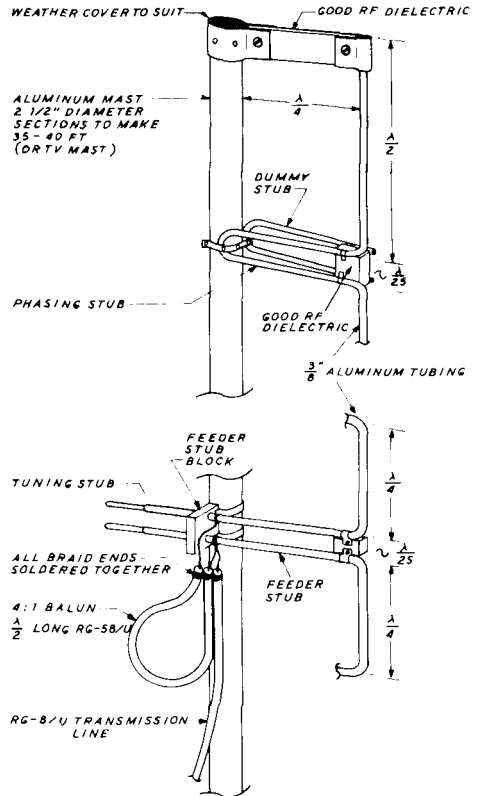
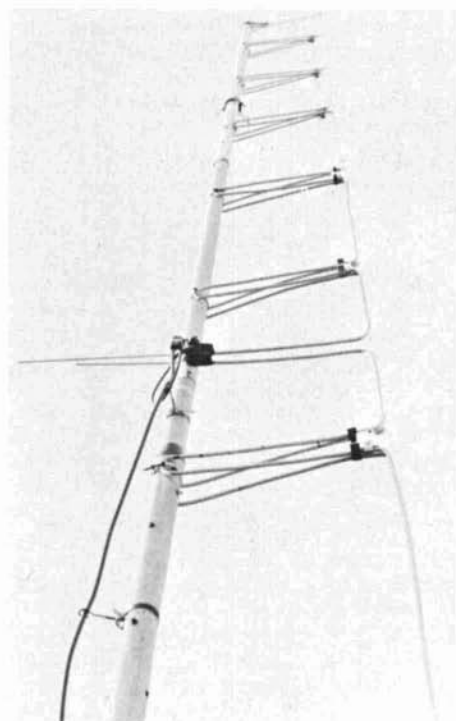

fig. 1. Construction details of the 9-element colinear antenna.

included for added support. Stubs and dipoles are formed from 12-foot pieces of 3/8-inch OD tubing connected together. Nominal lengths of the dipoles and stubs are respectively 38 and 19 inches. Hand-book formulas were used so that you may calculate dimensions to suit a particular portion of the band desired. The stubs are nominally 3½ inches wide (1/25 wavelength).

Each bent length of tubing is connected to the next with short pieces of aluminum tubing secured with sheet-

metal screws. In its final form, the antenna will consist of two long lengths of tubing. In my case, one length contained five and one half  $\frac{1}{2}$ -wave dipoles, five  $\frac{1}{4}$ -wave stubs, plus half of the feeder stub. The other length consisted of three and one half  $\frac{1}{2}$ -wave dipoles, three  $\frac{1}{4}$ -wave



**Feed arrangement and stub detail. Plastic box houses balun and feed connections.**

stubs, plus the other half of the feeder stub.

The antenna could be built symmetrically, each section consisting of two identical lengths of four and one half  $\frac{1}{2}$ -wave dipoles four  $\frac{1}{4}$ -wave stubs, plus one-half of the feeder stub. However, I built my antenna as shown to fit my installation requirements. A colinear antenna may be fed by splitting any of its dipoles into  $\frac{1}{4}$ -wave elements with the feeder stub, or it can be so fed between any of its dipoles.

### **tube bending**

Aluminum tubing may be bent in

several ways. You can carefully heat the material while bending it around a mandrel, or the tube may be filled with sand to provide "body" while bending. I found that the 12-foot lengths could be bent by hand without using a mandrel. Merely bend slowly and carefully to avoid kinks. Make some practice bends with scrap tubing to determine where the tubing starts to kink. You can then determine the optimum bending radius by feel, assuming an average "wrist strength." The bending radii do not have to be as small as shown. With practice, the tube-bending job can be done without special tooling. The "wrist-strength" criteria, together with care and practice, should yield stubs about 3 to 3½ inches outside width. Soft-drawn aircraft-type tubing works well. Aluminum electrical conduit, which may be obtained from mail-order houses, also works well.

### **dummy stubs**

A novel feature of this antenna is the use of dummy  $\frac{1}{4}$ -wave stubs for added structural support. Because the open end of a  $\frac{1}{4}$ -wave stub represents an infinite impedance, dummy stubs may be added in this manner without impairing antenna performance. The antenna is supported by the phasing stubs and dummy stubs, which are fastened to the aluminum mast using scrap aluminum straps and sheet-metal screws. A good electrical rf connection should be made between the stubs and the mast. This is achieved in part by using many sheet metal screws while remembering that every screw hole weakens tubing. Use all-aluminum hardware wherever possible to avoid electrolysis problems due to dissimilar metal contact.

Note also that pieces of scrap teflon are used for additional bracing at the high-impedance ends of the stubs, at the feeder-stub block, and at the mast supports for the two extreme dipole ends for added stability. Any other good dielectric material can be used, such as polystyrene.

The mast base rests in a Christmas-tree support weighted with a few bricks. However, the principal support comes



from a homemade scrap sheet-iron clamp securing the mast to the eave siding (see photo). Inside the attic are two steel straps bolted through the siding to the clamp. The straps are L-shaped and are bolted to an attic floor joist. Three lightweight nylon rope guys provide addi-

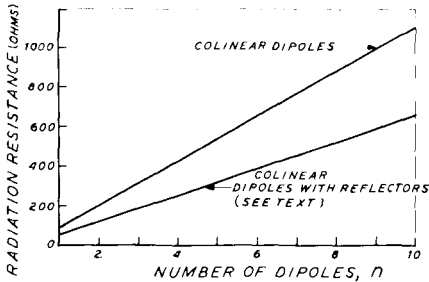

fig. 2. Radiation resistance of a colinear antenna as a function of the number of dipoles.

tional support against the wind. The guys are spaced about 120 degrees apart and are attached two-thirds of the way up the mast.

### feeding and tuning

Feeding and tuning procedures are straightforward. Since it was desired to feed this antenna with coax, a balun was needed to match the balanced feeder stub to the coax cable. As depicted in fig. 2, the theoretical radiation resistance of a nine-dipole colinear without reflectors is about 1000 ohms. However, an assumption is made (supported by experimental verification of the calculated radiation patterns, as discussed below) that each portion of the aluminum mast acts somewhat as a reflector for its corresponding dipole, so that the antenna can be construed as consisting of nine colinear dipoles with parasitic reflectors. The mast reflectors are spaced  $\frac{1}{4}$ -wave from their respective dipoles, and are assumed to be of equal length. Fig. 3B shows that a parasitic element of approximately the same length as a dipole and spaced  $\frac{1}{4}$ -wave away reduces the dipole input resistance to about 52 ohms. Assuming that this resistance increases with the number of dipoles, it is seen from the

lower curve of fig. 2 (drawn to correspond to this trend), that the radiation resistance of nine colinear dipoles with reflectors is about 600 ohms. A 4:1 step-up balun in parallel with the tuning stubs is used to match 52- or 72-ohm coax.

The antenna was tuned by first inserting an swr bridge as close as possible to the feed point. The coax was disconnected about 18 inches from the feed point for this purpose. Two pieces of aluminum tubing about 18 inches long were inserted into the feeder-stub tubing ends to provide a sliding fit. The tuning stubs were then adjusted for minimum swr.

### bandwidth

This antenna is sufficiently broadband so that, even though its minimum swr occurs at 147 MHz (fig. 3A), the swr is below 2:1 over the entire two-meter band. The stubs and dipoles could be made slightly longer than 19 and 38 inches, respectively, to move the minimum swr point lower in frequency. To

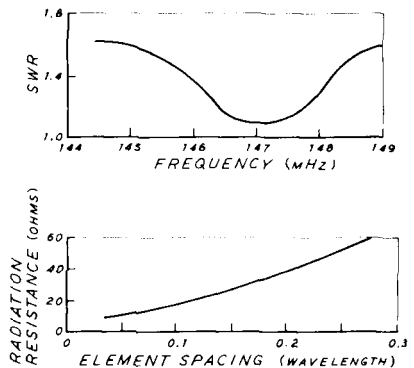

fig. 3. Measured swr of the 9-element colinear over the 2-meter band (upper curve). Lower curve shows radiation resistance of a dipole with parasitic element for various spacings (from reference 2).

calculate such small changes in length, note that the percent increase in required dipole and stub lengths is essentially equal to the percent frequency decrease.

From the photo, it is seen that the tuning-stub lengths are unequal, indicat-

ing asymmetry in the antenna currents about the feedpoint. To achieve symmetry, the fifth dipole should have been split by the feeder stub. Instead, the fourth dipole from the bottom was split

A comparison of power gain in dB may be obtained from the curves of **fig. 4D** if the numerical value of each point of the curves is converted to its logarithm. The power gain, therefore, of a 9-element

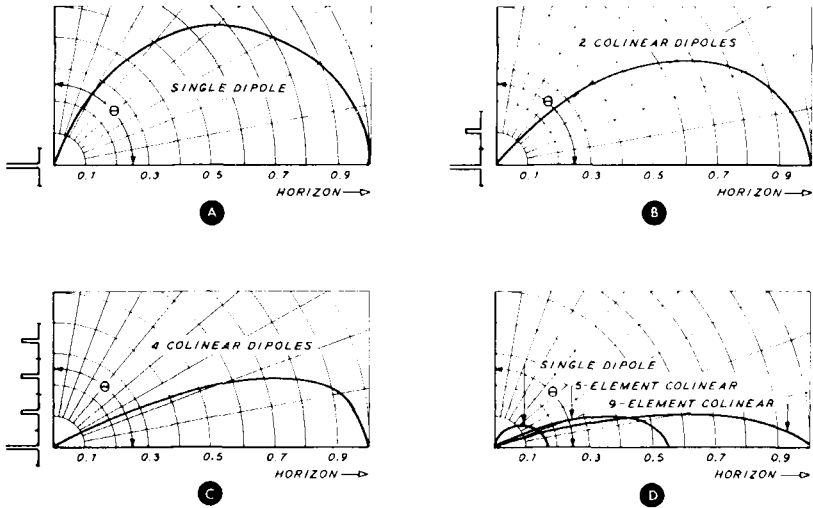

**fig. 4. Free-space polar radiation patterns of colinear antennas without reflectors.**

to attain a convenient height for tuning from a stepladder. Asymmetrical feed, if not exaggerated (such as feeding from an extreme-end dipole), generally results in only second-order effects on the radiation patterns, including a slight beam uptilt out of horizontal in this case.

### radiation patterns and gain

The curves in **fig. 4**, which represent polar radiation patterns in free space, show what may be expected (theoretically) as phased colinear dipoles are added to a simple dipole antenna, also in free space. It is seen that the addition of phased dipoles causes the radiation pattern to exhibit a flatter shape. **Fig. 5** shows the relationship between maximum gain and the half-power beamwidth, as a function of the number of added dipoles, over an *isotropic radiator*. Note that the gain of a single dipole (**fig. 5**) is referenced to approximately 2 dB, which is generally accepted as its gain over an isotropic radiator.

colinear array is about 8 dB over that of a single dipole, or 10 dB over an isotropic radiator (see **fig. 5**).

The curves in **fig. 4** are graphical expressions of the magnitude of the free-space polar-field radiation patterns of colinear antennas without reflectors:<sup>1</sup>

$$F_n(\theta) = \frac{\sin(90^\circ n \cos\theta)}{n \sin(90^\circ \cos\theta)} \times \frac{\cos(90^\circ \cos\theta)}{\sin\theta}$$

where  $n$  is the number of dipoles in the array (each dipole is assumed driven by a separate exciter, all of equal power, which is approximated by our single-dipole feed and the phasing-stub arrangement). The angle  $\theta$  is the zenith angle, measured from directly overhead of the antenna to the horizon for a vertically polarized colinear.\*

\*The number of minor lobes (not shown) of the polar patterns of **fig. 4** is given by the smallest integer nearest the value  $(n-1)/2$ , where  $n$  is the number of dipoles. For example, 8 and 9 dipoles would have 3 and 4 minor lobes respectively.

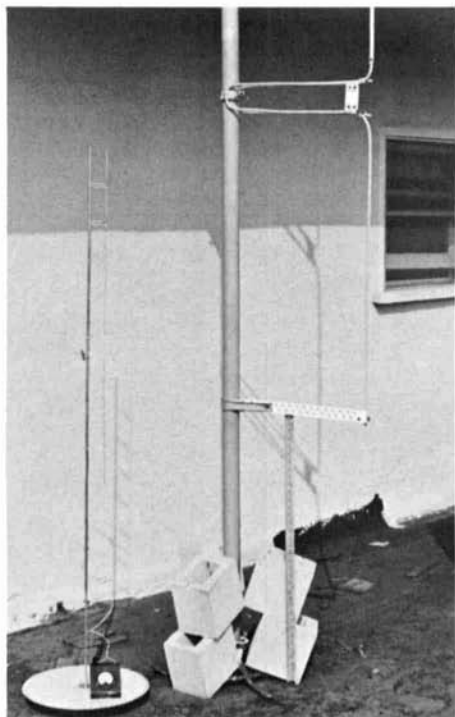

At left, the 1296-MHz antenna used for measurements. Bottom portion of the 2-meter colinear is at right with the yardstick included for scale. Mechanical mounting strength mainly comes from a clamp under the house eaves rather than the simple Christmas tree stand shown here.

The maximum gain in dB, in the horizontal direction, is<sup>1</sup>

$$G_{\max} = 10(\log_{10} 120 - \log_{10} R/n + \log_{10} n)$$

where  $R$  is the radiation resistance. As the number of dipoles,  $n$ , is increased beyond three or four,  $R/n$ , the array radiation resistance, approaches a constant value of about 110 ohms.<sup>1</sup> Thereafter, the gain becomes proportional to the log of the number of dipoles, so that doubling the number of dipoles gives only a three-dB increase in gain. For example, the gain of a nine-element colinear is about 8 dB over a single dipole. Doubling to 18 dipoles, perhaps by stacking, would yield but 11 dB gain. This logarithmic behavior of gain with the number of elements generally holds for most antenna arrays including quads and Yagis.

## azimuthal patterns

The vertically polarized colinear without reflectors has an omnidirectional radiation pattern in the azimuthal plane (plan view of antenna) in free space exactly like a single dipole. With a metal mast, however, the colinear is construed as nine colinear dipoles with reflectors, as discussed earlier. Then, looking down on top of this antenna, the azimuthal radiation pattern is, to good approximation, similar to a single half-wave dipole with an equal-length reflector, spaced  $\frac{1}{4}$  wavelength from the dipole. Such a configuration yields a minor lobe opposite in direction to the major lobe. The minor lobe is 3-6 dB below the major lobe, which is confirmed by experimental data, as shown below.

## experimental data

To verify that the metal mast does give a single minor azimuthal lobe opposite in direction to the major lobe, with a front-to-back ratio of 3-6 dB, a 1/9-scale antenna model was built to simulate the two meter colinear patterns. The scale-model antenna was cut for 1285 MHz. It was made of no. 14 tinned wire with a 3/8-inch copper tubing mast. The experimental antenna patterns were obtained using an AN/APX-6 converted surplus IFF transponder transmitter.

The resulting experimentally deter-

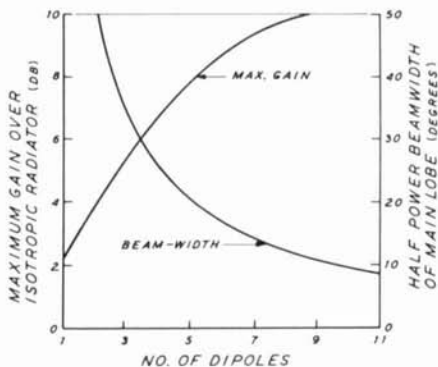

fig. 5. Relationship of maximum gain and half-power beamwidth to the number of colinear dipoles in the array.

mined azimuthal pattern is plotted in fig. 6 and does indeed show the minor lobe opposite in direction to the major lobe, with the former about 3-6 dB down from the latter.

to that from a single driven dipole and reflector of equal length spaced  $\frac{1}{4}$  wavelength away. The conjecture that this antenna acts like nine stacked reflected dipoles, one above the other, seems to be

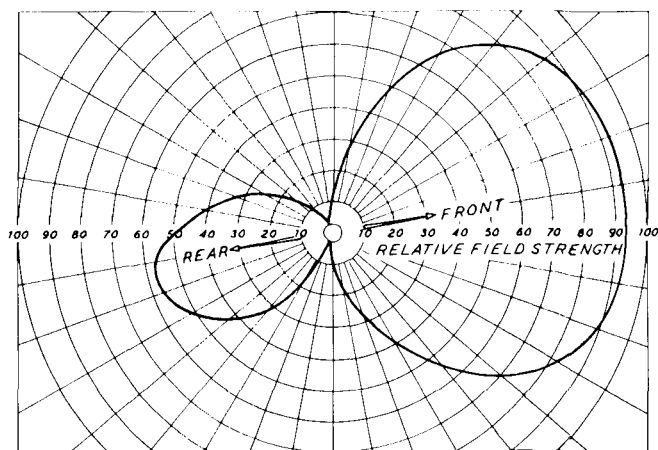

fig. 6. Azimuthal-field pattern of 1/9-scale model 9-element colinear.

The model antenna was mounted by its mast onto a pivoting lazy susan (temporarily sacrificed for the cause) on which a cardboard setting circle was glued. A 1N21 diode was connected in series with the feed point. Two rf chokes (6 turns of hookup wire,  $\frac{1}{4}$  inch dia.) were then connected in series with 300-ohm twin lead, which fed the rectified rf to the foot of the mast where a sensitive current meter was placed near the setting-circle base.

The APX-6 transmitter was coupled to a 4-foot parabolic dish, (F/number 0.25) with a vertically polarized dipole feed. The dish illuminated the scale-model colinear, which acted as a receiving antenna. Readings were taken as a function of azimuth angle of the model.

### conclusions

This antenna provides about 8-10 dB gain over an isotropic radiator in the horizontal direction. The metal mast (as borne out by experiment) apparently acts as individual reflectors for each of the nine dipoles. This yields an azimuthal pattern and 3 dB azimuthal gain, similar

confirmed at least in terms of its azimuthal patterns as seen in fig. 6. The analogous situation in terms of polar patterns is open to question at this time. I believe, however, that the basic polar pattern does not change radically from that in free space, as depicted in fig. 4D.

The antenna was originally built as a five-dipole colinear array and was soon after lengthened to nine dipoles. Good reports have been received to distances of 100-plus miles.

I would like to thank K6OQK and WA6MEM for assistance in measuring the azimuthal patterns of the model. W6MMU loaned me his APX-6 and parabolic dish, which resulted in final pattern measurements of the antenna model.

### references

1. R. W. P. King, "The Theory of Linear Antennas," *Harvard University Press*, Cambridge, Mass., 1956.
2. W. I. Orr, "Beam Antenna Handbook," Second Ed., *Radio Publications*, Wilton, Conn., 1955, p. 69, fig. 2.
3. Bob Dahlquist, WB6KGF, "Four-element Colinear Array for Two Meters," *ham radio*, May, 1971, p. 6.

ham radio

# gamma-loop-fed vertical dipole

Proven on 2-meter fm  
and the citizens band,  
the gamma-loop-fed  
vertical half-wave antenna  
offers easy erection  
and tuneup

William I. Orr, W6SAI

Owners of four-element quads and many prominent DXers are quick to denounce the simple ground plane as an antenna "that radiates equally poorly in all directions." Notwithstanding this opinion, many antenna manufacturers are quick to point out their more popular and fastest moving item in the amateur line is the simple, easily erected, low-cost ground plane. In addition, many of the robust-sounding signals from overseas DX stations are radiated from ground planes, according to the information on the QSL card.

That's what makes a horse race. The ground plane cannot be brushed aside as a worthless antenna because many amateurs do use it, and work lots of DX with it. Commercial and other services make use of the ground plane and improved versions of it for vhf point-to-point and mobile services. Many amateurs approve of it as a compact, low-profile antenna, well suited for portable work and for a quick installation that does not irritate neighbors.

## the vertical dipole antenna

An improved variation of the ground

plane has been in military and commercial service for some time. It affords somewhat better operation than the common version and does away with the usual radial system. This version consists of a half-wavelength vertical dipole radiator with a "ground independent" feed system.<sup>1</sup> Various versions of this antenna system are shown in fig. 1. It is well suited to either fixed or mobile operation.

The half-wavelength dipole provides about a 2-dB gain over the usual quarter-wavelength monopole antenna which is a worthwhile increase in performance for a minor alteration in size.<sup>2</sup> In addition, the usual ground plane radials are not required with a half-wavelength antenna as the isolation from the feedline with this antenna is nearly complete if a perfectly-balanced center-feed system is used. The vertical dipole antenna tends to run into trouble, however, when end-feed is used, and the feed system is unavoidably

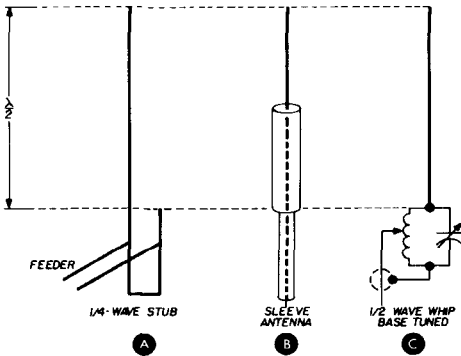

fig. 1. Simple end-fed vertical dipole antennas. (A) Quarter-wavelength stub and open-wire feedline were used in early thirties. Radiation from stub and line interfered with normally low-angle radiation of antenna. (B) Improved sleeve antenna used lower portion of dipole to act as shield for coaxial transmission line, reducing effect of line coupling to a great extent. (C) Vertical dipole matched to a low impedance coaxial line by means of a tapped resonant circuit.

coupled to the field of the antenna; antenna currents on the feedline tend to make it a part of the radiating system,

substantially altering the antenna field pattern.

The free-space radiation pattern of the ground plane and the vertical dipole are

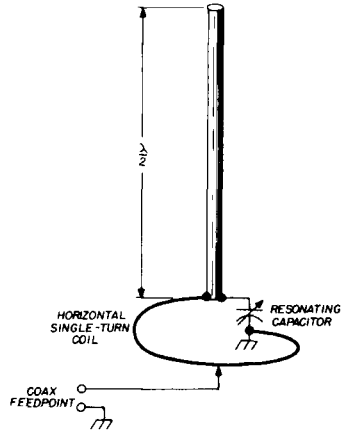
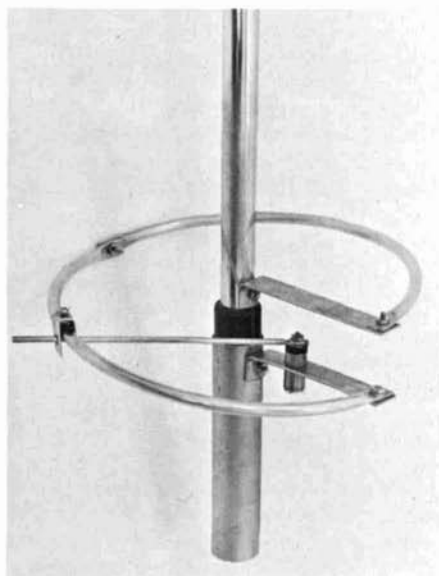

fig. 2. The gamma-loop-fed vertical dipole. Parallel-resonant circuit is mounted in the horizontal plane to reduce coupling to the antenna to a minimum value. Single-turn coil is tapped at appropriate spot for feedline. A practical version of this antenna is shown in the photograph.

equivalent figure-8 plots in the X-Y (vertical) plane provided that the feed system and antenna are not coupled to each other.<sup>3</sup> The pattern of either antenna close to the ground, then, is a function of ground reflection. Typical reflection patterns for these antennas are shown in the *ARRL Antenna Book*, and it can be observed that a reasonably low angle of radiation is obtained when the bottom of the vertical dipole antenna is less than a half-wavelength above ground.<sup>4</sup> This gives the user plenty of latitude in mounting the antenna, especially in view of the fact that the theoretical ground reflection patterns are distorted by the real-life environment surrounding the antenna.

The free-space radiation plots show that a vertical half-wave antenna may be mounted with its center as much as three-quarter wavelength above ground before the vertical radiation pattern begins to rise appreciably. For the 20-meter band, this means that the bottom

of the vertical may be  $\frac{1}{2}$ -wavelength, or about 35 feet above the ground surface. The vertical could therefore be mounted atop the roof of a one- or two-story



Cush-Craft gamma-loop-fed vertical dipole for 10 and 11 meters has loop broken into two parts for ease in shipment, and capacitor is made up of dielectric sleeve between two sections of vertical tubing. Gamma rod reaches from coaxial plug at right to moveable clamp on inductor at left.

house without apprehension. In view of the character of the ground around typical amateur installations, moreover, and considering the influence of nearby objects, the free-space radiation plot can be considerably blurred, and the half-wave vertical has given good DX results when mounted at heights of over 80 feet above ground (atop a 4-story building, for example).

Conventional wisdom has it that the radials on a ground plane lower the angle of radiation of the antenna, and that the more radials employed, the lower the radiation angle. A more correct view is that the radials decouple the outside of the coaxial transmission line from the ground plane antenna and provide a low

impedance ground point for the outer shield of the transmission line at the base of the quarter-wave antenna. If the radials are missing, the line acts to provide the missing quarter-wave section of the antenna, or more, if the line has appreciable length. The antenna plus transmission line, then, is transformed into a long vertical antenna having a high angle of radiation, most of which is useless for long distance communication.

### a practical feed system

The feed system for the half-wave vertical antenna must provide a good impedance match between the high-impedance antenna end-point and the low-impedance transmission line, and must decouple the outside of the line from the field of the antenna. These two requirements can be met without the use of radials by the technique shown in fig. 2. A parallel-tuned, gamma-matched resonant circuit is used, positioned in such a way as to offer minimum coupling to the antenna element. The inductor is a large, horizontally mounted, single-turn loop and the parallel capacitor is a fixed, high-voltage ceramic unit. By varying the length of the antenna, the size of the coil and the tap point on the coil, a good impedance match may be achieved for either a 50- or 70-ohm coaxial transmission line.\*

To insure that the coaxial line is not coupled to the antenna once it leaves the tuned circuit, the line should ideally be led away at right angles to the antenna. This is usually not practical, so a ferrite rf choke is placed along the transmission line about one-eighth wavelength away from the coupling circuit. The choke is simply made up of two turns of the transmission line threaded through a large ferrite core. Induced currents on the outer shield of the line attempting to turn the line into a long-wire antenna are

\*The antenna shown in the photograph is manufactured by Cush Craft, 621 Hayward Street, Manchester, New Hampshire 03103, and is intended for either 10- or 11-meter operation.

suppressed at this point (fig. 3).

The single-turn inductor and capacitor are resonant at the operating frequency of the antenna. For the antenna illustrated, this is 28.6 MHz. For those wishing to roll their own, a nomograph

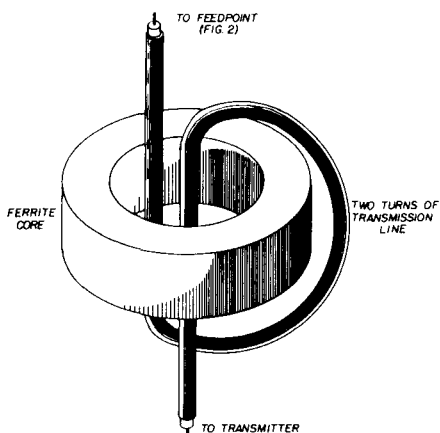

fig. 3. Coaxial line may be decoupled from field of antenna by looping the line through large ferrite core, making simple rf choke in series with outer shield of line. Choke is placed a few feet below the antenna. A suitable core is the Indiana General CF-123 toroid, 2.4 inches in diameter (Q-1 material having a permeability of 125 at 1 MHz). Available as catalog number 59F-1518 from Newark Electronics Corp., 500 North Pulaski Road, Chicago, Illinois 60624. Transmission line is looped through core twice, but is shown as only once, for simplicity of illustration.

for determining the inductance of a large single-turn inductor is given in fig. 4.<sup>5</sup> The inductance value should be chosen so as to resonate the tuned circuit to the operating frequency with a capacitor whose value in picofarads is about two to four times the wavelength in meters.

The ten-meter antenna in use has a 50 pF ceramic capacitor, with an inductance of about 0.7  $\mu$ H. The coil is made of 3/8-inch aluminum tubing, about 11 inches in diameter. The coil and capacitor combination are grid-dipped to frequency on the bench before being mounted on the antenna.

## antenna adjustment

The dipole is cut to one-half wavelength by formula and connected to the pre-tuned base network. The antenna may be mounted in the clear, about head-height on a step ladder for initial adjustment. The tap on the base inductor is moved back and forth, a half-inch at a time until the point of lowest swr is found. This is done while feeding a few watts to the antenna from the station exciter. If this adjustment does not produce a low value of swr (say, less than 1.5 to 1), the length of the whip or the diameter of the coil may be varied a bit to bring the whole system into resonance. The tap, antenna length and coil diameter are all interdependent. But with the information given, you are in the ball park and only minor tweaking is needed to bring the swr to near-unity at your design frequency. Once the correct adjustments are determined, they are locked, and the antenna is ready to place in the final operating position.

## no radials

Properly isolated from ground, the vertical half-wave dipole requires no radials. The use of the line choke and positioning of the feedline beneath the antenna insures minimum coupling between line and radiating element. A quick test of line isolation may be made by clipping a single quarter-wave horizontal radial to the coaxial shield of the line at the base of the antenna. If adding the radial changes the swr to an appreciable extent, parasitic coupling exists between the line and the antenna and the addition of one or two radials is suggested. If the addition of the temporary radial does not alter the swr, it is not needed. Leave it off.

## operation

The half-wave vertical antenna provides about 2 dB gain over the ground-plane antenna and places the point of maximum current a worthwhile distance higher in the air, assuming the same base mounting point as a conventional ground



plane. In addition, radials are not required to make it work properly. This is all to the good. Such an antenna has been used with some success at the author's portable QTH in Hawaii (KH6ADR) and,

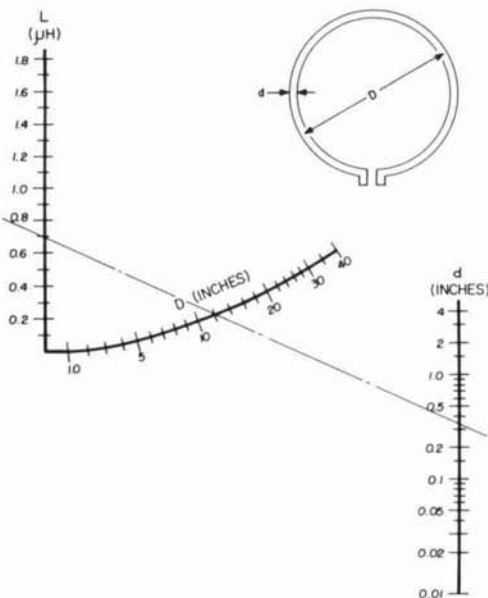

fig. 4. Circular loop inductance nomograph. An 11-inch coil of 3/8" aluminum tubing, for example, exhibits about 0.7  $\mu$ H inductance.

while comparisons are really invalid, it seems to out-perform the ground plane previously used. In any event, DX can be worked and the antenna functions well and is very inconspicuous. What could be a better testimonial than this for such a simple and unpretentious installation?

#### references

1. "Antennas and Propagation," *Communications Designer's Digest*, October, 1969.
2. Jasik, "Antenna Engineering Handbook," McGraw-Hill, New York, New York.
3. Bailey, "TV and Other Receiving Antennas," Rider, New York, New York.
4. ARRL, Newington, Connecticut.
5. Terman, "Radio Engineer's Handbook," McGraw Hill, New York, New York. (Nomograph originally given in "Bureau of Standards Bulletin," Vol. 8, 1912.)

ham radio

# AMATEUR ELECTRONIC SUPPLY

- has -

## ROBOT

*In Stock for  
Immediate Delivery*

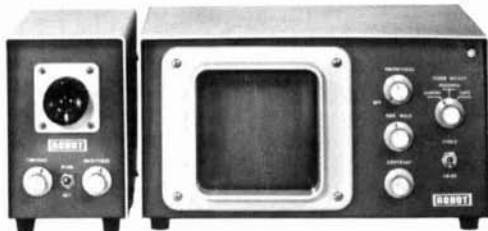

- ROBOT MODEL 70 MONITOR .. \$495
- ROBOT MODEL 80 CAMERA .. \$465
- 25mm, f1.9 lens ..... \$ 30
- 25mm, f1.4 lens ..... \$ 40
- 25mm, f1.4 Macro lens ..... \$ 60

## AMATEUR ELECTRONIC SUPPLY

4828 West Fond du Lac Ave. Milwaukee, Wis. 53216  
Phone (414) 442-4200

HOURS: Mon & Fri 9-9; Tues, Wed & Thurs 9-5:30; Sat 9-3  
CLEVELAND Area Hams may wish to visit our Branch store located at: 17929 Euclid Avenue, Cleveland, Ohio. Ph. 486-7330. Pete Smith, Mgr. ALL Mail Orders and Inquiries should be sent to our Milwaukee store.

### To: AMATEUR ELECTRONIC SUPPLY

4828 W. Fond du Lac Ave, Milwaukee, Wis. 53216

I am interested in the following new equipment:

I have the following to trade: (what's your deal?)

Ship me: \_\_\_\_\_

I Enclose \$ \_\_\_\_\_; I will pay balance (if any):

- COD (20% Deposit)       GECC Revolving Charge Plan  
 Master Charge\*       BankAmericard       American Express

Account Number: \_\_\_\_\_

Expiration DATE \_\_\_\_\_ + Master Charge Interbank number \_\_\_\_\_ (4 digits)

Name: \_\_\_\_\_

Address: \_\_\_\_\_

City & State: \_\_\_\_\_

- Send used gear list       Send Robot literature

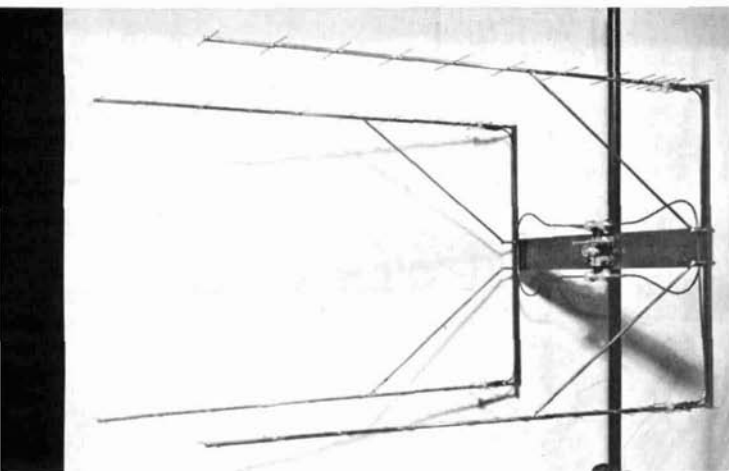

## a successful 1296-MHz Yagi

Here is  
a 1296-MHz quad Yagi  
which overcomes  
the usual  
construction problems  
and provides gain  
equivalent to  
a four-foot dish

It is well known that the Yagi is probably the best all-around antenna for vhf. It is easy to build, provides high gain with low weight, and offers low wind resistance. However, it is often hard to scale down a Yagi to work on the 432- or 1296-MHz bands. The poor performance often experienced on these frequencies has led to the erroneous assumption that "Yagis won't work at uhf."

I feel that the much-publicized poor performance of the uhf Yagi comes about because the dimensions given for director lengths—the most critical part of a Yagi—simply do not scale down properly. For example, if the experimenter simply scales a two-meter Yagi down to 1296 MHz, without doing any additional measurements, he will usually obtain mediocre results.

### design

The 1296 MHz, 13-element antenna shown in **fig. 1** is a scaled version of Orr and Johnson's famous long Yagi, which, for the past eight years, has given outstanding results on 144 and 432 MHz at my station.<sup>1</sup> The parasitic elements are

Reed E. Fisher, W2COH, 2 Forum Court, Morris Plains, New Jersey

lengths of AWG 14 copperweld wire soft-soldered to a boom made of 1/4-inch OD brass tubing. The copperweld provides both physical strength and high electrical conductivity, the second condition being required for effective Yagi operation. The director lengths, the most critical dimension of the antenna, have been arrived at by careful pattern measurements on an antenna test range.

A few words of caution: Do not use directors or boom of different diameter than specified. Also, do not use an insulated boom. Any of these modifications will detune the directors.

### driven element

The driven element, shown in fig. 1 and the photo is a delta-matched dipole also constructed of AWG 14 copperweld pushed through the boom center and secured by a Plexiglas block and set screw. The delta-matching section consists of two pieces of AWG 14 soft copper wire soldered to the dipole.

The driven element is fed by a half-wavelength loop balun constructed of 0.085-inch OD solid coax. The balun is excited by the main feedline made of 0.141-inch OD solid coax. Both balun and main feedline are soft-soldered to the brass boom. The solid coax is probably the main contributor to the success of

this Yagi, since it provides a compact and low loss feed arrangement. The Teflon-dielectric 0.141-inch coax exhibits a loss-per-foot comparable to RG-8/U.

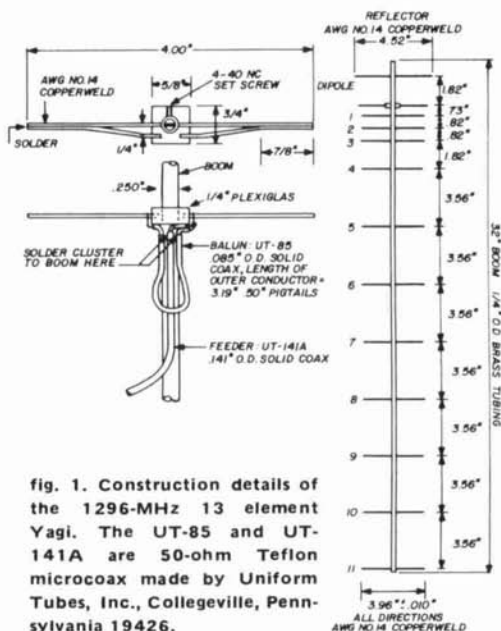
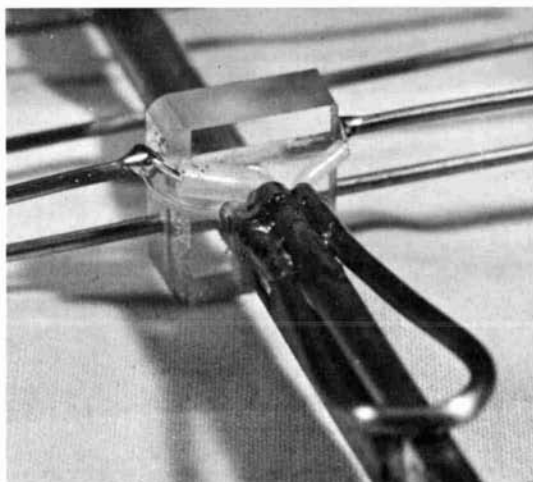

fig. 1. Construction details of the 1296-MHz 13 element Yagi. The UT-85 and UT-141A are 50-ohm Teflon microcoax made by Uniform Tubes, Inc., Collegeville, Pennsylvania 19426.

### performance

A single Yagi exhibits 15.2 dB gain (over isotropic radiator) when compared with a 15.0-dB gain reference horn antenna. Figs. 2A and 2B show the azimuth (E plane) and elevation (H plane) patterns of the Yagi, measured at an industrial laboratory test range by R. H. Turrin, W2IMU. Note that in fig. 2A the first sidelobes are down about 9.5 dB, a condition necessary for effective Yagi operation. If the builder has any doubts about the correctness of director lengths, he should measure the first sidelobe levels. If they are not down by at least 9 dB, the Yagi is not working properly.

When the patterns of figs. 2A and 2B were integrated in 1° increments, antenna directivity was found to be 17.55 dB. This number corresponds closely to that given by the well known approximation,



Detail of the dipole and feed arrangement.

$$\text{directivity} = 10 \log \frac{41253}{\theta_E \theta_H} = 17.70 \text{ dB}$$

where  $\theta_E$  and  $\theta_H$  are respectively, the -3 dB E-plane and H-plane beamwidths in

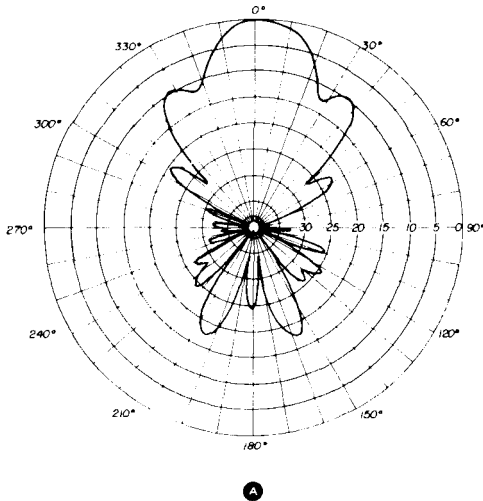

## matching

My final quad Yagi array uses 20-inch spacing between antennas. This array provides 21-dB gain which is comparable

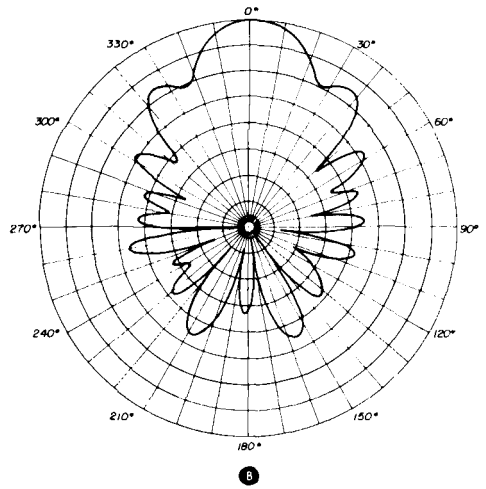

fig. 2. Azimuth pattern of the antenna.

degrees. Since antenna directivity and gain differ by the element skin resistance losses, we must conclude that for this Yagi these losses amount to about 2.5 dB. This emphasizes the importance of building the antenna elements from low-loss metals such as copper.

The single Yagi should exhibit a vswr not exceeding 1.2:1 (with respect to 50 ohms). The vswr will increase to above 2:1 when droplets of water cling to the dipole, but will recover to 1.2:1 when the antenna is shaken or allowed to dry.

to a four-foot dish. The matching network, located at the array center, is simplicity itself and is shown in fig. 3. Three type-N coaxial tees joined together will match four 50-ohm antennas into one 50-ohm generator with low vswr at 1296 MHz.

The matching theory is shown in the schematic diagram. The two 50-ohm loads (antennas) at the top of the diagram appear in parallel at *point A* and, thus, look like 25 ohms. This 25 ohms is transformed up to 100 ohms at *point B* by the quarter-wave-length 50-ohm matching section. The two 100-ohm loads at the *B junction* combine in parallel to again form 50 ohms, hence, the array is matched.

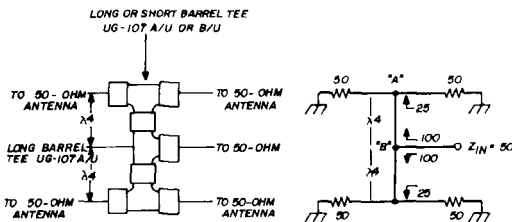

fig. 3. Matching network is made up of three, long barrel UG-107A/U coaxial tees. The matching schematic is also shown.

## reference

1. William I. Orr, W6SA1, and Herbert G. Johnson, W6QKI, "VHF Handbook," Radio Publications, Danbury, Connecticut, first edition, 1956.

ham radio

DYCOMM broadband, no tuning, ready to use boosters can increase your transmitted power up to 45 times.

# DYCOMM

## OFFERS MORE WATTS PER

Over 2,000 satisfied users  
have NEVER paid a cent  
for repair.

**500C "FM Booster"**, 4-12W in. 15-30W out. 10W input/output 25W. **\$59.95**



Fully automatic,  
hands off operation.  
DYCOMM offers a booster  
for use with virtually every  
2M FM rig.

DYCOMM boosters are  
reliable, inexpensive, straight  
forward, small in size  
and big in performance.

**500D "Block Booster"**, 8-12W in. 35-55W output 16W of drive is **FB**, this outstanding bargain is still only **\$89.95**



**500E "Brick" or TR22 Booster**, one of the most popular, your 1-2W HT can push out 20-25W. **\$69.95**

**500ES "Super Brick/TR22 Booster"**, Now you can have from 35-45W for .8-2 watts input. Typically 30W output/1W input. **\$99.95**

All boosters have automatic low insertion loss in/out switching. All operate from 12-15 DC. Isn't it time you also went DYCOMM? They are rugged; built to take vibration, load mismatch and over-voltage.

To order: See your nearest DYCOMM dealer, if none near you, order direct and add \$1.55 for shipment.

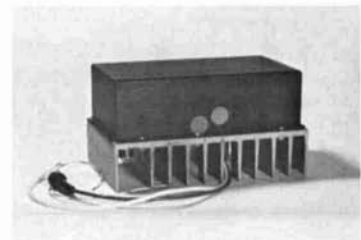

**10-0** The ultimate in solid state power 8-15 watts input will put out 80W min., 125W max. Typically 100W output/10W input; 90W minimum/10W input. **\$185.00**

**35-0** Provides 80-110W output for 25-40W input, typically 100W output for 35W input. **\$165.00**

For more information, call  
or write: JIM — W4MRI

**DYNAMIC  
COMMUNICATIONS  
INC.**

948 Avenue "E"  
Riviera Beach, Fla. 33404  
305-844-1323

# direct reading and expanded scale swr meters

An inexpensive surplus meter presents a novel method to read forward power, reflected power, and swr — simultaneously

Most amateur radio stations use an swr meter to indicate the approximate standing-wave ratio of their antennas. The meter also indicates the relative output power of the transmitter. The standing-wave ratio is the ratio of the reflected power to the forward power.

A signal proportional to each of these powers comes from a directional (parallel wire) coupler with rectifier diodes. Most swr meters must be adjusted in sensitivity so that the voltage corresponding to the forward power will give a full-scale meter

deflection. The meter is then switched to monitor the reflected signal, which will be less than full scale. The ratio of the reverse meter reading to the forward meter reading yields the proportional meter reading, M.

$$M = \frac{\text{reverse meter reading}}{\text{forward meter reading}}$$

The standing wave ratio may then be computed, based on a linear detector.

$$\text{swr} = \frac{1 + M}{1 - M}$$

The limitations, such as return feed-line loss, diode nonlinearity, and coupler directivity have been pointed out in past articles.<sup>1, 2, 3</sup> Because of its accuracy, the swr meter is used primarily to indicate relative improvements in matching. The meter described here will be as accurate as the above limitations permit. The meter does not need to be normalized. Also, a scale-expanding technique will be described.

## single meter indicator

Many amateurs have monitored forward and reflected power by using two meters. You may adjust a matching network to decrease the reflected power while constantly watching the forward reading. The obvious extension of this approach is to combine the two meter

Earnest A. Franke, WA4WDK, 108 Matawan Terrace, Matawan, New Jersey 07747

movements into one case. The relative power scales remain while the needle crossing indicates the ratio of the values.

I modified an I-101 glide path indicator meter to display these measurements. Glide path receivers are used to guide pilots while making their final landing approach in instrument flight weather. Several of these cross-point indicators are available in surplus for less than five dollars.\* Any stops restricting needle movement from twenty degrees on either side of the rows of luminescent dots must be removed. The small counter-balancing needle weights must be bent inward slightly. Any manipulation of the bearing or meter movement must be avoided.

A scale suitable for pasting on the meter face is included in fig. 1. The zero adjust is varied so that each needle corresponds with the zero-power indications. The resultant indicator resembles the Bird model 3122 Thru-line wattmeter. An swr of 1:1 is obtained if the reflected power is equal to zero. Conversely, an infinite swr exists if the reflected power is equal to the incident power.

The scale of fig. 1 is based on the 1.31 power law detector response, discussed by Jerry Hall, which approximates most

detectors.<sup>2</sup> A more exact standing-wave ratio formula would then be

$$swr = \frac{1 + \sqrt[1.3]{M}}{1 - \sqrt[1.3]{M}}$$

The various ratios for normalized meter

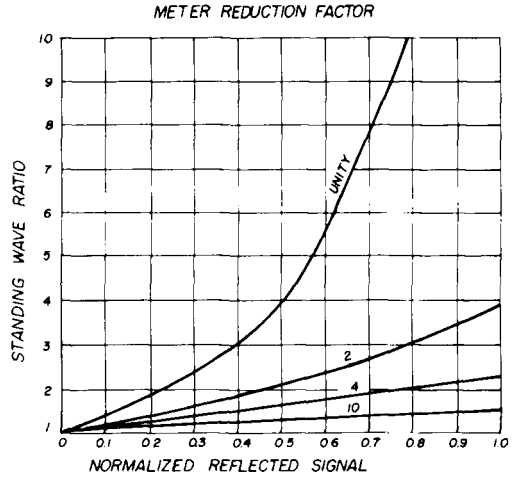

fig. 2. Graph shows the expanding effect of reducing the forward signal.

readings are shown in fig. 2. The curve labeled unity is the one to use without meter-expanding devices. The schematic of the cross-point indicator with the optional expander is given in fig. 3.

**scale expander**

Most amateurs must turn down the sensitivity of their swr meters, especially at increasing frequencies because the length of the sampling wire becomes a greater portion of the wavelength as the operating frequency is raised. If the signal corresponding to the forward power were attenuated, the sensitivity control would have to be increased. When, in a conventional meter, the meter is switched, the reflected signal will deflect the needle further.

Swr-coupler operation is based on the

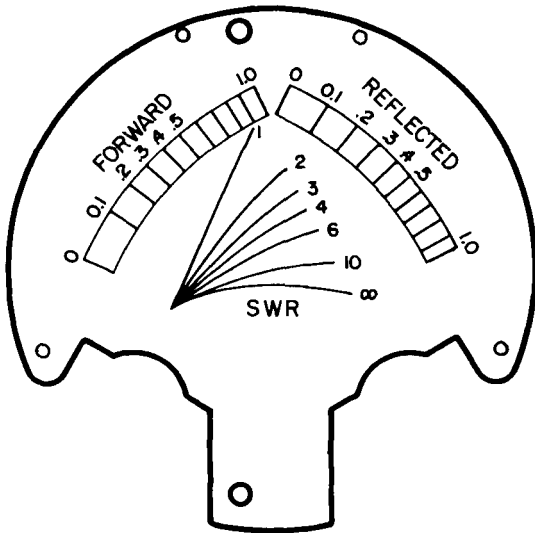

fig. 1. An swr scale to use on the cross-point indicator without the meter expander.

\*Fair Radio Sales Company, Box 1105, Lima, Ohio 45802 sells government reconditioned I-101 cross point indicators for \$2.95 plus shipping.

fact that the sampling diodes are nearly matched to each other. Each diode drives the same or equal resistances. The response of a detector is affected by the meter resistance. If part of the forward-power meter current is shunted by a resistor, the resistance seen by the diode decreases. This shunting effect must be compensated by a series resistance in order to match the load through which the reverse signal current will flow. If a resistance equal to the meter resistance is placed in parallel with the indicator meter, the needle will swing to one-half its former value. A meter reduction factor,  $N$ , of two is achieved. A series resistor of one-half the meter resistance must be added to the shunt combination

$$R_{SH} = \frac{R_M}{N - 1}$$

where  $R_{SH}$  = shunting resistance

$R_M$  = meter resistance

$N$  = meter reduction factor

$$R_{SE} = \frac{(R_M)^2}{R_M + R_{SH}}$$

The value of  $M$ , the normalized reflected signal, is increased by the meter

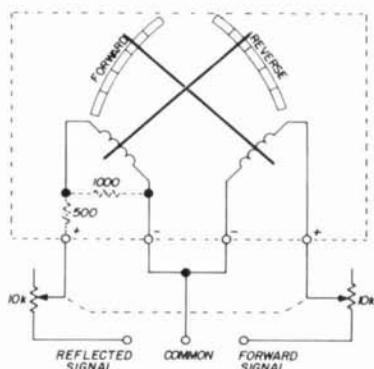

fig. 3. Cross-point swr indicator that eliminates the normalizing or calibrating action. Two ganged 10k pots provide sensitivity control.

reduction factor.\* A new normalized reflected signal ratio is indicated when the reflected signal is monitored.

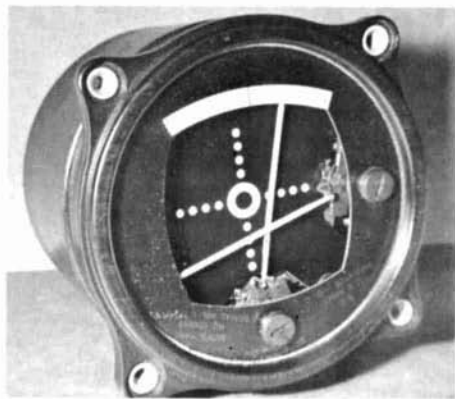

Photo of the Signal Corps I-101 cross-point indicator.

$$M = \frac{(M \text{ indicated})}{(\text{meter reduction factor})}$$

This new value may be inserted in the previous swr formula.

An example is shown that might be applied to most swr indicators. Suppose the meter has been adjusted to full scale while monitoring the forward signal, and the reverse signal is to be measured. A half-scale deflection,  $M = 0.5$ , corresponds to an swr of 4:1. If a resistance equal to the meter resistance is added in shunt, and another resistor added in series, the meter will be deflected down to one-half the previous reading. The sensitivity control must be turned up so that the forward signal will still deflect full scale. The reflected reading will also double. The full-scale reading has thus expanded to a 4:1 swr indication of full scale. This assumes that there is enough signal to provide a full-scale deflection in

\*In normalized readings, one key value is called 1, and all other readings are related to this. In using Smith charts, for example, 50 ohms is the reference and is called 1. 70 ohms becomes 1.4 and 30 ohms becomes 0.6. If, in swr measurements, you call a forward reading of 25 watts 1, a reflected reading of 5 watts becomes 0.2. If the actual reflected reading was written as  $R = 5$ , the normalized reading would be indicated by  $R' = 0.2$  with the prime signifying a normalized reading. For minds conditioned to the decimal system and percentages, normalized readings are often a handy tool. editor.





Photo of the I-101 converted to a direct-reading swr meter.

the forward position. Fig. 2 shows the expanding effect of reducing the forward signal.

The correlation between swr and the reflected signal reading becomes linear as the forward signal is reduced. If you have a large signal available from the swr coupler and a low standing wave ratio, the expander will allow a magnified reading of the meter. Fig. 4 shows a

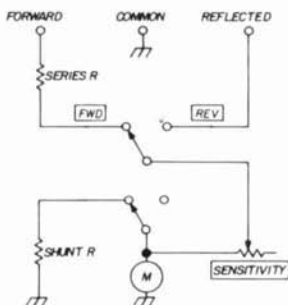

fig. 4. Modification to a conventional swr indicator to expand the scale.

schematic of the expander added to a conventional swr indicator.

#### references

1. Byron Goodman, W1DX, "The Versatile Standing-Wave Ratio Indicator," *QST*, June, 1958, pages 15-18.
2. Jerry Hall, K1PLP, "Accuracy of SWR Measurements," *QST*, November, 1964, pages 50-53.
3. Louis D. Breetz, "Possible Errors in VSWR Measurement," *QST*, November, 1959, pages 22-23.

ham radio

# KIRK

## ALL FIBERGLASS HELICOIDAL BEAMS

- NEWEST  
REVOLUTIONARY  
DESIGN
- LIGHTEST  
3EL. 40M 46 LBS.  
3EL. 20M 21 LBS.  
3EL. 15M 15 LBS.  
STACKING  
PLATE MOUNTS  
AVAILABLE

BY  
W8FYR

● COMPLETE  
WITH BALUN,  
MATCHING  
DEVICE AND  
T MOUNT.

HANDLES  
POWER FAR IN  
EXCESS  
OF MAX.  
LEGAL LIMITS.

1. ALL FIBERGLASS  
EL. & BOOM.
2. EL 25% TO  
30% SHORTER.
3. NO TUNING  
NO ADJUSTING.

4. VSWR FLAT  
ACROSS 80%  
PHONE-CW  
BAND.
5. STURDY  
CORROSION-  
FREE CON-  
STRUCTION.

**NO CORROSION — NO EROSION  
THE ARRAYS THAT LAST  
NEW LOWER PRICES**

MODEL 7MH2 - 2EL 40 METER WAS \$435.00, NOW \$345.00
MODEL 7MH3 - 3EL 40 METER WAS \$665.00, NOW \$525.00
MODEL 14MH4 - 4EL 20 METER WAS \$379.95, NOW \$299.00
MODEL 14MH5 - 5EL 20 METER WAS \$479.95, NOW \$379.95
MODEL 21MH5 - 5EL 15 METER WAS \$339.95, NOW \$269.95

**ALL ARRAYS REDUCED ACCORDINGLY**



## KIRK Electronics

134 WESTPARK RD., DAYTON, O.  
45459      PHONE 513/433-3102

# an all-band phased-vertical antenna system

Phased  
groundplane verticals  
offer directivity,  
multiband operation and  
mounting flexibility  
without buried radials

Endeavoring to design an antenna system for my home, I had a stiff list of requirements. I wanted:

1. Operation on 80 through 10 meters with reasonable efficiency and low swr at all operating frequencies,
2. Small physical size to fit on a postage stamp size lot (not large enough to support a long wire, dipole or inverted-V),
3. Selectable antenna directivity to enhance medium-power operation (200 watts) and reduce interference,

4. Low cost—precluding towers and rotators, and
5. Reasonable esthetics in deference to good neighbors.

No available antenna system is known to meet all of these requirements, hence the design of this system has involved a series of compromises. It is felt, however, that the system to be described is a reasonable compromise applicable to other locations. This system has been in use at my station since the spring of 1970, and its operation has been proven in many contacts on all bands, including some DX.

## theory and design

Since dipoles, inverted-Vs, long wires and beam antennas were not consistent with the system constraints either because of physical size, cost or non-selectable directivity, the first approach was to examine vertical antennas. A vertical antenna does not require a lot of space, does not cost much money and is reasonably esthetic. In addition, recent articles have discussed the advantages of operating two verticals at various phase angles to obtain varying antenna patterns.<sup>1, 2, 3</sup> Generally speaking, feeding both antennas in phase (0° phase angle) results in an antenna pattern favoring a line at right angles to the plane of the two antennas (broadside pattern), whereas feeding one antenna out of phase (180° phase angle) results in a pattern favoring a line in the plane of the two antennas (endfire

Ernest S. Chaput, WA7GXO, 5027 Reiter Avenue, Las Vegas, Nevada 89108

pattern), and feeding one antenna  $90^\circ$  out of phase favors a line off one end of the plane of the two antennas. Other phase angles produce other patterns generally less useful for amateur purposes. In these previously published articles, the phase angle is achieved by feeding each antenna with a different length of coaxial cable.

For my specific application, two phase angles are of interest:  $0^\circ$  and  $180^\circ$ . These two phase angles produce antenna patterns which are rotated  $90^\circ$  from each other: north-south and east-west. Feeding both antennas with the same length feedline produces the  $0^\circ$  phase angle and its broadside pattern, and is suitable for multi-band operation.

Two methods can be used to generate the  $180^\circ$  phase shift needed for endfire operation: make the feedline to one antenna  $\frac{1}{2}$ -wavelength longer than the feedline to the other antenna, or reverse the conductors of the feedline to one antenna. The first method is generally used for single-band operation, but is not feasible for multi-band use because there is not a  $\frac{1}{2}$ -wavelength difference between the two feedlines on the different bands, and, hence, not always a  $180^\circ$  phase shift. For example, a  $\frac{1}{2}$ -wavelength difference on 40 meters ( $180^\circ$ ) is only  $\frac{1}{4}$ -wavelength difference ( $90^\circ$ ) on 80 meters. Although not employed here, by properly selecting antenna spacing and feedline dimensions the  $180^\circ$  phase shift can be maintained for operating frequencies which are odd multiples of each other—such as 40 and 15 meters.

The second method of obtaining the  $180^\circ$  phase shift is not possible for coaxial fed antennas because, in a normal installation, the feedline is unbalanced

with one side of the feedline grounded. This method is feasible, however, if the antennas are fed with a balanced transmission line like open-wire feeder. I chose the system of feeding two ground plane vertical antennas with open-wire feeders of equal length and having the ability to remotely reverse the feedline to one antenna. Open-wire feeders necessitated an antenna tuner, but allowed the construction of vertical antennas without the usual coils or traps. Appropriate coils are required for the antenna tuner, however. Fig. 1 summarizes my system.

### construction

Construction of this antenna system is fairly simple and uses readily available materials. The only critical factor is retaining a fair degree of symmetry in the construction and installation of the two antennas so that *predictable* antenna patterns will result and each antenna will carry half of the radiated power. The construction details given are illustrative only; they can surely be improved. Since my system was designed to fit on my house roof, the physical size and mounting details were developed accordingly. The size of each ground plane antenna was primarily dictated by the eve-to-eve dimensions of the roof. I used 25 feet for the vertical element and for the ground plane radials. The base of each antenna was supported ten feet above the peak of the roof.

I used thin-wall electric conduit for the vertical element, and number 16

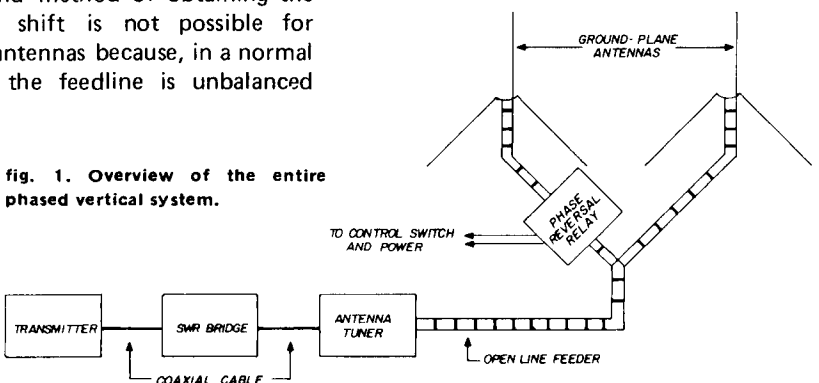

fig. 1. Overview of the entire phased vertical system.

table 1. Theoretical system gain with an antenna spacing of 35 feet.

frequency (kHz)	wavelength spacing	antenna broadside	gain dB endfire
3,750	0.15	0.5	4.2
7,150	0.28	1.2	3.7
14,200	0.55	4.5	2.0
21,250	0.80	4.5	2.0
29,000	1.10	2.5	4.0

antenna wire for the radials. Rigidity dictated  $\frac{3}{4}$ -inch conduit. Since conduit is usually sold in ten-foot lengths, the vertical element must be spliced to achieve the 25-foot overall length. The splices must be mechanically rigid and electrically conductive. I used five-foot lengths of  $\frac{1}{2}$ -inch conduit inside the  $\frac{3}{4}$ -inch conduit at each joint. Some shimming is necessary to achieve a rigid splice.

A ten-foot length of  $\frac{3}{4}$ -inch conduit was also used to support the antenna off the peak of the roof. The ground plane radials also acted as guy wires at the ten-foot level. Non-conductive guys (I used 50-pound test fishing line) are used at the thirty-foot level. Fig. 2 details the construction and mounting of the antennas.

### phase-reversal system

Insert a double-pole, double-throw relay in the feedline to one antenna for the phase reversal and antenna pattern shift. I used a surplus relay with ceramic insulation and  $\frac{1}{4}$ -inch contacts, but any relay with large enough contacts and insulation to handle the transmitted power should be adequate. Be careful when installing the relay so that the feedline length is not significantly altered as the relay is operated. In addition, the feedline spacing should be maintained through the relay. Enclose the relay in a plastic box for protection from the weather. The relay control line should be run at 90° from the feedline for as long a distance as possible.

### antenna tuner

The basic tuner design was taken from the *ARRL Handbook*, and utilized series and parallel tuning to match a wide range

of antenna reactances.<sup>4</sup> Two band-changing options are available: plug-in coils for each band, or one set of coils with appropriate taps. I chose the latter option because the L/C ratios for matching the antenna on each band could be determined by experimentation. Either a heavy duty rotary switch or alligator clips can be used to change bands. Fig. 3 is a schematic of the antenna tuner. Note that C2 and C3 must be isolated from ground and from each other. In constructing this tuner, I used the variable capacitors from

fig. 2. Details of the construction and installation of each of the vertical elements.

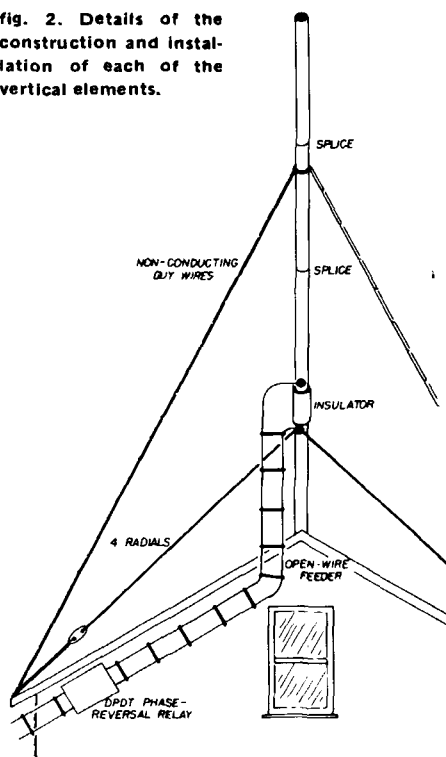

an ARC-5 transmitter for C2 and C3, removed the worm gear drive screw, and drove both capacitors in tandem with an insulated fibre gear.

### orientation and spacing

Antenna gain for both endfire and broadside arrays is a function of the wavelength spacing between the two driven elements.<sup>5</sup> If the spacing is either

too close or too far apart, the antenna has either no directivity and no gain, or it becomes very directive with a very narrow pattern. Since this system was designed for general amateur operation, fairly broad patterns (90°) with moderate gain on all hf bands was desired. Available space may dictate the spacing, however. I used 35 foot spacing at my station. Table 1 summarizes the *theoretical* system gain for each hf band (on-the-air contacts have verified the relative gains between broadside and endfire patterns).

Since this antenna array is directive, and since its gain and pattern width varies for the different bands, the antenna system spacing and orientation should be chosen by determining the direction of the desired patterns for each band.<sup>1</sup> At this location, for example, the 80- and 40-meter performance is adequate for all stateside contacts, and so the antenna was oriented to optimize directivity towards Europe (endfire) and Asia (broadside) on 20 meters. The orientation of the antenna is, at best, a compromise.

## operation

An swr bridge is essential for the proper operation of this antenna system. Proper antenna tuning is indicated by minimum swr and maximum power out. There is considerable interaction between the antenna tuner and the output circuitry of the transmitter, so adjustment of both sets of controls is required. Basic steps in system tune-up are:

1. Select an operating frequency. Select the proper antenna coil taps for resonance (if the taps are properly determined, then one set of taps will cover a complete amateur band).
2. Determine the proper phase angle to enhance radiated power in the desired direction.
3. Adjust the antenna tuner for minimum swr. It is suggested that this step be performed at low power since a very high swr may be encountered initially. Adjust the transmitter output circuitry for maximum power out. Readjust the antenna tuner for mini-

mum swr. It should be noted that additional adjustment of the antenna tuner may be required as the phase angle is changed, even if the operating frequency is not changed.

The antenna system has lived up to its design expectations. It has provided de-

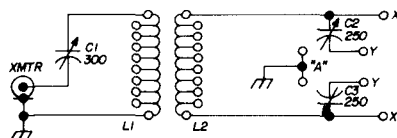

C2,C3 250 pF. Salvaged from ARC-5 transmitter

L1 8 turns, 6 turns per inch, 2-inch diameter. Tapped each turn. L1 is placed inside of L2 with the taps of L1 coming out between the turns of L2

L2 40 turns, 6 turns per inch, 2 1/4-inch diameter. Tapped 2, 4, 10 and 20 turns each side of the center.

fig. 3. Schematic of the antenna tuner. Connect the antenna at the points marked "X" for parallel tuning; "Y" for series tuning. When using parallel tuning, connect the grounded jumper "A" between C2 and C3.

sired directivity and gain on all hf bands, yet its patterns are broad enough to assure that I can work all directions. The extra chore of adjusting the antenna tuner can be bothersome, but the system's overall advantages more than compensate for this problem. I am sure that this system can find use at other stations.

## references

1. John Schultz, W2EEY, "Improving the Performance of Trap-Type Vertical Antennas," *73*, June, 1970, pages 52-54.
2. James Lawson, W2PV, "A 75/80 Meter Vertical Antenna Square Array," *QST*, March, 1971, pages 18-20.
3. James Lawson, W2PV, "Simple Arrays of Vertical Antenna Elements," *QST*, May, 1971, pages 22-27.
4. "The Radio Amateur's Handbook," pages 341-344, American Radio Relay League, Newington, Connecticut, 1968.
5. "The ARRL Antenna Book," pages 145-150, American Radio Relay League, Newington, Connecticut, 1964.

ham radio

# small-loop antennas

## Radiation patterns, design and theory for an effective limited-space antenna

A small loop antenna is any constant-current loop with a perimeter not exceeding about one-third wavelength. Larger loops can be made to have a constant current around the perimeter through the use of appropriately-spaced phasing devices. The characteristics of such loops, however, are quite different from those of the small loop, and depend, rather critically, on the precise shape of the loop.

Most of the advantages of the small loop are pretty obvious from this definition. Most important of all is that the loop takes up considerably less space than

the corresponding half-wave linear antenna. Also, since the characteristics are determined chiefly by the area of the loop, rather than by the shape, they can be made round, square, or any other convenient shape with little change in performance. Among their disadvantages is very narrow bandwidth and disconcertingly low radiation resistance.

Less well known is the effect of the proximity of a large reflecting plane, such as the ground — particularly at the 3.5- to 14-MHz range — the ground is never very far away in terms of wavelength, and it therefore becomes an integral part of the radiating system. This causes the field pattern to deviate markedly from the simple doughnut shape which occurs in free space. It also may have a pronounced effect on the radiation resistance.

Ground reflection characteristics are customarily developed by first assuming the ground to be perfectly conducting, and then substituting an image antenna for the ground plane. The problem is thus reduced to that of an array of two similar antennas, which is not only much simpler than a reflection problem — it also has been solved with sufficient generality to apply without modification to loops. Here we shall concern ourselves chiefly with the results of the calculations, rather than with the formulas themselves. The typical examples shown should give a

E. G. Von Wald, W4YOT, 424 North Dixie, Lake Worth, Florida 33460

good picture of the situation. For those who wish to examine other specific cases, the necessary material is included in an appendix to this article.

Figs. 1 through 4 display the directional characteristics of horizontal loops, while figs. 5 through 9 are devoted to vertical loops. For the latter, the pattern

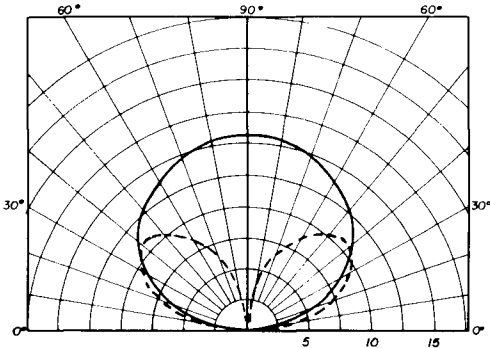

fig. 1. Horizontal loop vs horizontal dipole, both at one-eighth wavelength above ground. For all the patterns in this article, the antenna is assumed to be over a perfectly conducting ground.

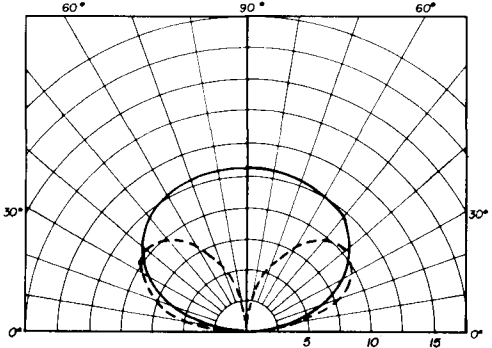

fig. 2. Horizontal loop vs horizontal dipole, both at one-quarter wavelength above ground. In all figures the dipole's pattern is the solid line and the loop's pattern is the broken line.

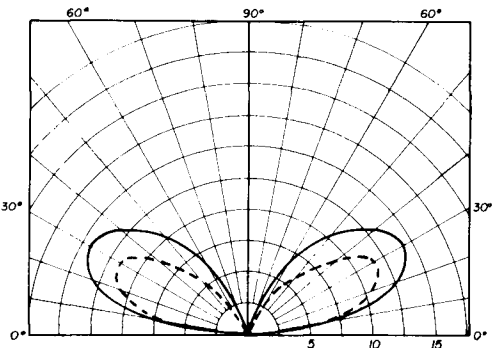

fig. 3. Horizontal loop vs horizontal dipole, both at one-half wavelength above ground.

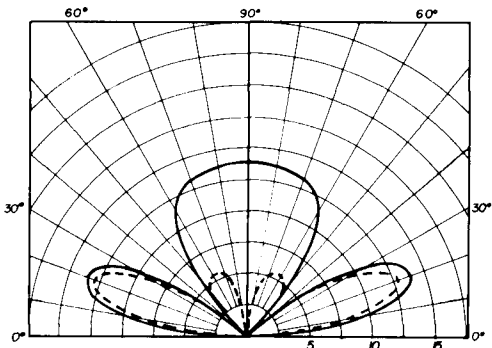

fig. 4. Horizontal loop vs horizontal dipole, both at three-quarter wavelength above ground.

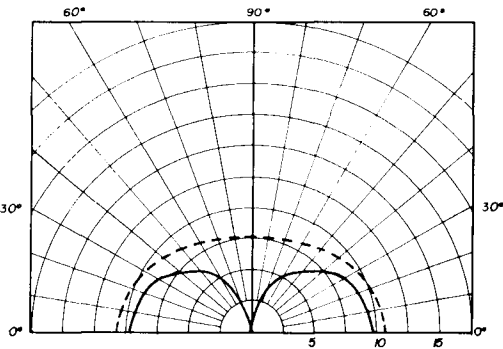

fig. 5. Loop vs linear antenna, both one-eighth wavelength above ground. Both antennas are vertically oriented in this and figures 6, 7, 8 and 9.

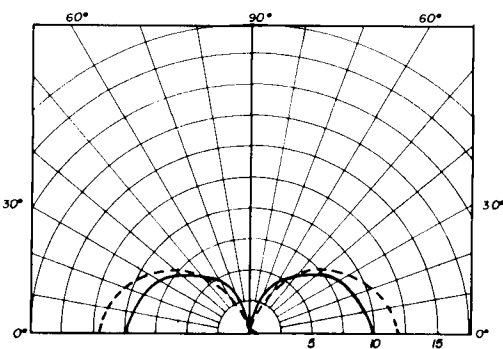

fig. 6. Loop vs linear antenna, both one-quarter wavelength above ground.

shown is that in the plane of the loop. The quantity plotted is the field strength at one meter, and is measured in volts per meter for one watt input to the antenna.\* Since actual field-strength units are used, it is possible to compare the performance of the different antennas directly. For example, it has been claimed that the so-called "army loop" is equivalent to a horizontal dipole about one-sixth wavelength high. The reader can pick off a good approximation for each from the charts given here, and can decide for himself how closely this claim approaches reality.

The purpose for which an antenna is intended should be borne in mind when considering alternatives. DX chasing requires low angle radiation, but for a couple-hundred-mile range it is the higher angles that are most useful. Considerable directivity is sometimes an advantage, as when there is heavy interference from a direction other than the desired one. On the other hand, this sometimes requires

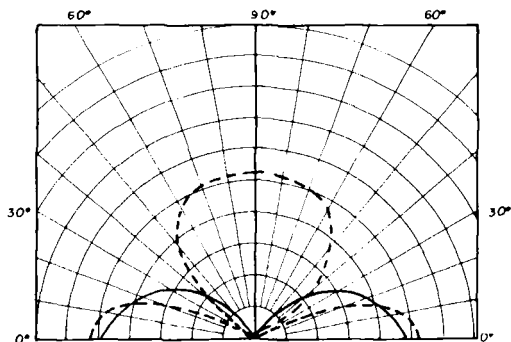

fig. 7. Loop vs linear antenna, both one-half wavelength above ground.

rotating the antenna to give adequate coverage.

Looking at the charts, it can be seen how the directivity of the antennas plays

\*Some texts use as standard the field of one kilowatt at a distance of one mile. The values given in the charts can be converted to this by dividing by 1609 — the distance of one mile in meters — and by multiplying by the square root of the power — 1000 watts. **editor.**

its role. In the horizontal group, the loop radiates equally in all geographic directions, and as a result its radiation pattern is noticeably smaller than that of the dipole. Even so, for the longer distance

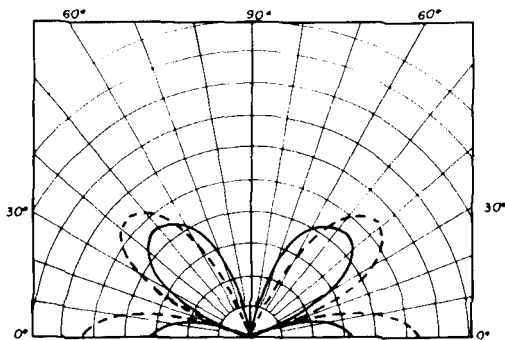

fig. 8. Loop vs linear antenna, both three-quarter wavelength above ground.

contact, the two are very nearly equal. The same cannot be said for short haul work, however. At a height of three-quarter wavelength, for instance, the low angle lobes are almost identical, while at the higher angles the loop responds only feebly compared to the dipole. This might be considered quite a good thing under certain circumstances. If horizontal polarization is desired, the loop is usually easier than a dipole to put up in a densely populated area. And it is precisely in such areas that heavy interference from short range stations is most likely to be encountered.

In the vertical group, the situation is different. Here it is the loop which is the more directive in the horizontal plane. The result is that it readily outperforms the linear antenna. Of course, this is only in the plane of the loop. Off the side, the signal will be down, just as it is down off the ends of a horizontal dipole. The most marked advantage of the loop for DX work appears when the antenna is between one-quarter and five-eighths wavelength high. See fig. 9. Here, the loop shows a gain of three to four decibels over the linear antenna. This is equivalent to a two-element beam.



As with all high frequency antennas, radiation at extremely low angles is greatly attenuated by ground absorption. The charts, therefore, are not reliable below nine or ten degrees.

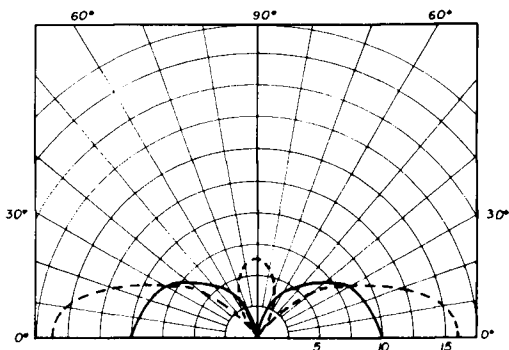

fig. 9. Loop vs linear antenna, both five-sixteenth wavelength above ground. This is the height at which the gain of the loop over the linear antenna is maximum.

### losses and efficiency

All the above has been based on the presumption of zero internal losses in the loop — that the loop is composed of a lossless conductor. This may seem to be begging a very important question in view of the admittedly very low radiation resistance of the loop. What interpretation, then, can be placed on such examples? The answer, of course, is that the presence of internal losses reduces the radiated power, and the comparisons to the linear antennas are no longer valid. The directional characteristics, however, should remain much the same. Furthermore, although no antenna can be made truly lossless, this condition can actually be approached in practice.

Let's examine this matter a little further.

First, we need a practical example. Let's compute the radiation resistance of a small loop. The formula for this is given in one form or another in most books on antennas as follows:

$$R_r = 31,200 \left( \frac{A}{\lambda^2} \right)^2$$

where  $R_r$  is the radiation resistance and  $\frac{A}{\lambda^2}$  is the area of the loop in square wavelengths. If there are several turns in the loop, the radiation resistance given above is multiplied by the square of the number of turns. However, we are only considering single-loop antennas here.

Let's assume a round loop with a radius of 0.05 wavelength.

$$R_r = 31,200 (\pi r^2)^2$$

$$R_r = 31,200 (3.14 \times .0025)^2$$

$$R_r = 1.94 \text{ ohms}$$

This corresponds to a forty-meter loop about fourteen feet across.

Suppose we use copper clad downspouting three inches in diameter for a conductor. To compute the losses in the conductor, we need the resistance — the high-frequency resistance, not the dc resistance. For round, tubular or solid copper conductors, this quantity is given by

$$R_{hf} = \frac{\sqrt{F}}{1000d} \text{ ohms per linear foot}$$

where  $F$  is the frequency in megahertz and  $d$  is the diameter in inches.<sup>1</sup> If aluminum is used, multiply the result by 1.28, the ratio of the square root of the resistivity of aluminum to that of copper.

The high-frequency resistance for our example figures out to be about 0.039 ohm total.

Now, the radiation efficiency of an antenna can be determined by the following formula:

$$\% = 100 \frac{R_r}{R_r + R_{loss}}$$

Here, this comes out as

$$100 \left( \frac{1.94}{1.94 + .039} \right) = 98\%$$

Since it is doubtful that a 2% loss could be measured at any distance, this can be taken as an example of an essentially lossless antenna.

It might be instructive to consider what happens if the conductor is made about fourteen feet across.

Suppose we use copper-clad down-tubing. The high-frequency resistance of this conductor is twelve times that of the three-inch material, or about 0.466 ohms. Yet when this is plugged into the efficiency formula, the result is still 80%. This represents a loss of approximately one decibel.

Now let us assume we wish to use the same size loop and tune it down to the low end of the eighty-meter band. What do we run into in this case? Well, the radiation resistance can be computed by using the formula above. However, we can obtain the same result somewhat more quickly by noting that the radiation resistance is inversely proportional to the fourth power of the wavelength. If the wavelength is doubled, the radiation resistance is divided by  $2^4$ , or 16, which gives us a figure of approximately 0.12 ohms for our loop at 3.5 MHz.

Using the quarter inch copper tubing, the efficiency falls to 27%. This sounds rather low, but in point of fact it is roughly thirteen times the efficiency of a bottom loaded eight-foot whip mounted on an automobile, at the same frequency. The three-inch material, however, produces the more desirable efficiency of about 80%.

In actual practice, there are other and less readily-calculated sources of loss in a small loop. One of the worst offenders is the discontinuous joint. Where conductors are merely twisted together, or bolted, the current is not only crowded into a small space, but often must flow through layers of oxide and accumulated dirt. Remember, here we are dealing not in ohms, but in tenths of ohms. When the radiation resistance is very low, as it is in loops, joints — where unavoidable — should be either soldered or welded. Bare conductors should be sprayed with plastic paint to preserve the surface from corrosion. Corners should be rounded where possible. And after attention to all of these things, it is still wise to employ a belt-and-suspenders technique by choosing a somewhat larger conductor size than actually required by the figures.\*

## ground and radiation resistance

So far, we have only considered the loop's free-space radiation resistance. The fact that the ground reflection has such a pronounced effect on the radiation pattern should prepare us for the likelihood

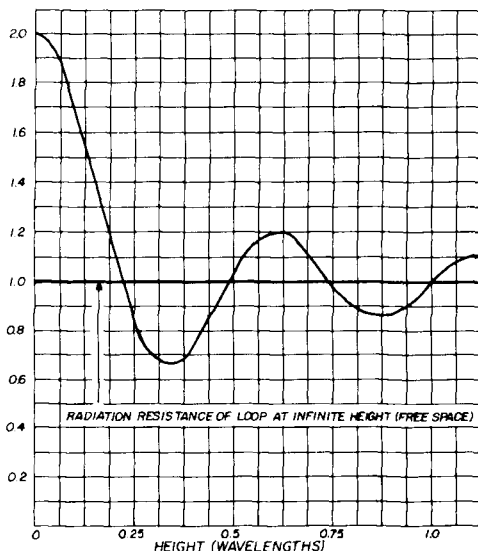

fig. 11. The ratio of the radiation resistance of a small horizontal loop near ground to that of the same loop in free space.

of a similar effect on the radiation resistance. This proves to be the case, and fig. 10 and 11 tell the story.

What the charts display is not radiation resistance itself, but something more general. It is the *ratio* of the radiation resistance of a loop near ground, to that of the same loop in free space. These charts are applicable to small loops of any size whatever.

It will be observed that a vertical loop has its resistance doubled when very close to ground, while the resistance of the horizontal loop tends to zero at the same

\*"Belt and suspenders technique." This term appears to have originated in connection with an eminent civil engineer of some years ago, who was well known for his reliable but extremely conservative structural design. To keep his pants up, this gentleman always wore both belt and suspenders — presumably on the theory that if one should unaccountably fail, his modesty would still remain intact. **editor.**

height. From this it is a pretty obvious conclusion that, unless it is to be elevated appreciably, the horizontal loop is pretty well ruled out. It is almost certain to suffer seriously from internal losses — this, even with the largest practicable conductor.

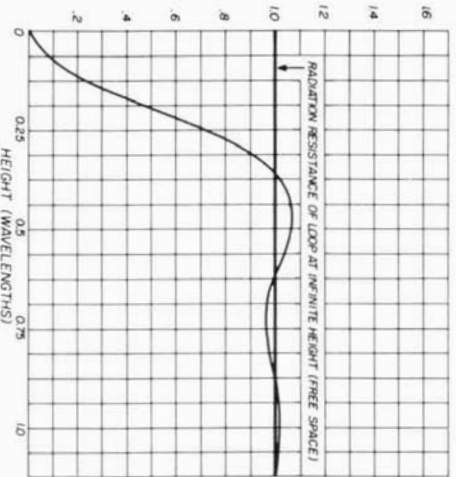

Fig. 10. The ratio of the radiation resistance of a small vertical loop near ground to that of the same antenna in free space.

#### appendix

The directional characteristics of loops near ground are given by the following expressions:

Horizontal loop  $E = \sqrt{R_{fs}/R_g} 2I \cos \alpha \sin(H \sin \alpha)$

Vertical loop  $E = \sqrt{R_{fs}/R_g} 2I \cos \alpha \cos(H \sin \alpha)$

where  $R_{fs}$  is radiation resistance in free space

$R_g$  is radiation resistance near ground

$H$  is height of antenna above ground in degrees

$\alpha$  is the angle above the horizon.

These are developed from a method called "pattern multiplication," in which the radiation pattern of an array of similar isotropic sources is multiplied by the radiation pattern of the individual real source. Further details may be found in J. Kraus, "Antennas," McGraw-Hill, New York, 1950.

#### reference

1. F. E. Terman, "Radio Engineer's Handbook," McGraw-Hill, New York, 1943, page 35.

ham radio

## UNIVERSAL Aluminum Towers are GREAT !

\* Strong \* Lightweight \* Easy to assemble \* Rust-Free (less maintenance) \* Self-Supporting  
Models are available from 30-90 feet with a choice of wind loads to meet your specific needs.  
Write us for literature. Shown here is a Model 18-50 (18 sq. ft. wind load - 50 ft. high) installed at Ted Willett's house (W9NHE), our Print Shop Manager. AMATEUR ELECTRONIC SUPPLY can recommend the proper UNIVERSAL TOWER to fit your particular needs.

# AMATEUR ELECTRONIC SUPPLY

4828 West Fond du Lac Ave. Milwaukee, Wis. 53216

Phone (414) 442-4200

# an antenna coupler

## for the three-band beam

Better harmonic suppression  
and improved loading of  
your three-band beam  
with this  
coax-to-coax matcher

There are many types of antenna couplers, and frequently they are designed to serve several purposes by a rearrangement of the components. This article covers a specific design: a coupler for a coax-to-coax match when using a three-band beam. The fact that it works equally well with coax-fed dipoles, and by a change of values it will work equally well on 3.5 and 7 MHz, is beside the point.

You may question the need of such a coupler. Read this article, make a few tests, and I think you will be convinced.

### advantages

An antenna coupler is not a magic box. It will not cancel standing waves on

the feeder and may do little to prevent radiation from the coax outer shield. It can, however, increase radiated power and attenuate harmonics—both are important items. This coupler, properly used, can do more. It can be used as an output power meter, and it is a first-class tool to use for obtaining an accurate match between antenna and feeder.

The pi-net output tank of a transmitter is intended to match the load resistance of the output tubes to the radiation resistance of the antenna (finally) and at least to provide a match to the coax feeder. In the perfect case, the transmitter will see a perfect load which will draw and dissipate the maximum power available.

The design of a pi-net is not simple. We need to know the exact plate voltage, full-power plate current and the load resistance to be fed before we can calculate the values for the plate inductor and loading capacitor. To obtain maximum power output, therefore, we must operate the tubes at their rated input power and present the correct load resistance.

If we have a transmitter designed to operate at X watts into a load of 50 ohms, it will be overloaded if it sees 40 ohms, and will not be loaded to full power with 60 ohms. It must have a load of 50 ohms to give its proper efficiency.

There is not a three-band beam in existence which will provide an exact load of 50 ohms at every frequency on all three bands with its coax attached directly to the pi-net output.

E. R. Cook, ZS6BT, 32 Grove Road, Gardens, Johannesburg, Republic of South Africa

If we use a dummy load of 50 ohms, the transmitter will tune up exactly at any setting and will load to rated input. What we need, primarily, is a device which will at least enable the transmitter to see its optimum load, just as though it were feeding a dummy load. In fact, the antenna should draw exactly the same power as the correct dummy load at any point in any band. Does yours? If it does, you do not need an antenna coupler!

Using 50-ohm coax into a transmitter rated 50 ohms, we do not require any

fig. 1. The basic Z-match. At resonance the inductive reactance and capacitive reactance cancel each other out.

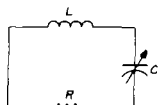

impedance transformation. We do need an unbalanced-to-unbalanced coupler which will cancel any reactance and allow the transmitter to see its proper load. This is not as simple as it sounds, but at least we are able to move in the right direction as a start.

## the z-match

The series-tuned circuit (z-match) is ideal for our purpose. The basic circuit is shown as fig. 1. At resonance, the reactances of L and C cancel each other and their net reactance is zero. The internal impedance is therefore equal to the value of the load R.

Even if R is reactive (such as a length of coax with a standing wave on it), the reactances form a part of the circuit together with L and C, and can be cancelled by adjusting the values of L and C. By using two such series-tuned circuits, (as in fig. 2) we are able to absorb any feeder reactance in circuit L1C1 and present the transmitter with its 50-ohm load.

## design

Let us first deal with the design and adjustment of fig. 2. L2C2 merely needs to be able to tune to resonance to any frequency between 14 and 29 MHz. This

can be done easily with 1- $\mu$ H inductor and a 200-pF capacitor. There is nothing critical in this part, except that C1 may see rf voltages as high as 300V with a 1-kW input, and L1 may carry as much as 5 amperes. Inductance and capacitor should be capable of handling these values—not a difficult matter.

Circuit L1C1 will need more inductance for 14 MHz. The capacitor may see as high as 1 kV of rf, currents as high as 5 amperes may pass through the inductance, and again, the components must be of appropriate rating. The inductance L1 may need to be around 4  $\mu$ H total to cover all three bands, and it may need tapping to provide 1  $\mu$ H for the two higher bands.

The experimental coupler was designed for 400W PEP. The capacitors were both 200-pF maximum, with C2 a good quality receiving-type and C1 of a type used in 50-watt transmitters. The coils were made from a single piece of coil stock, 11 turns long, 16 turns-per-inch

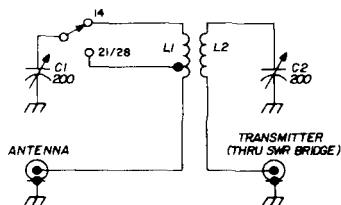

- L1 7½ turns, no. 18 wire, 1¼-inch diameter, 16 turns per inch (B&W no. 3023), tapped 3½ turns from hot end. Approximately 4  $\mu$ H
- L2 3½ turns, no. 18 wire, 1¼-inch diameter, 16 turns per inch (B&W no. 3023) approximately 1  $\mu$ H. Note: L1 and L2 are close-coupled on the same piece of coil stock, which altogether measures 11 turns

fig. 2. Schematic of the coax-to-coax antenna matcher and its installation with an swr bridge between the station transmitter and antenna.

stock, 11 turns long. The inductance was merely cut to provide two close-coupled coils of 3½ and 7½ turns. The larger coil coupling make sure that the transmitter is connected to the very *outside* turn of L2 and the antenna is tapped to the end of L1 closest to L2.

You need a dummy load and an swr bridge for initial alignment. On each band, load the transmitter into the dummy load and do not retune the transmitter controls. Insert the tuner between the dummy load and the swr bridge, set switch SW1 to the correct band and adjust C1C2 until the swr bridge (set to read reflected power) shows zero reflected current. Note the settings of C1 and C2 for resetting. As you make these adjustments, you will learn how C1 and C2 function in order to tune the coupler. I had no trouble with the 21- and 28-MHz bands during the basic alignment, but the behavior on 14 MHz should be noted. The amount of L1 in circuit should be varied by tapping the coil, until C1 is about half in. Do not remove the unused turns.

Remove the dummy load and connect the antenna in its place. Begin tuning on 28 MHz. It should be possible to adjust C1C2 so that zero reflected current is obtained on the bridge, although the position of C1 may not be the same as with the dummy load. At this point, mark the 28 MHz settings for C1C2; they will not vary very far over the entire 28-MHz band. Follow the same procedure for 21 MHz, and obtain calibration marks for future routine resetting.

Finally, set up for 14 MHz, and here the tests must be more exhaustive. Try three settings: 14,000, 14,150 and 14,300 kHz. If you obtain zero reflected current at all three, all is well. In the process you may need to vary the amount of L1 in the circuit as this will depend on the amount of reactance presented by the feeder. If the *supposed* resonant frequency of the antenna is known, check at this frequency also.

Experience says that it will be impossible to obtain a perfect match at all points on 14 MHz. However, at the points where matching is nearly correct, adjust the 14-MHz tap on L1 to ensure adequate capacitor movement. Although there may be a point where the bridge will not zero, the swr will not be too great and may be ignored for the moment.

The results of the coupler may now be assessed, both in transmitter loading (freedom from reactances) and behavior on the air. Output power will be higher and harmonic emissions should be attenuated by some 30 dB.

A refinement which you may add is an rf ammeter in series with L2C2. This will read the actual current in the link between the transmitter and the coupler, and output power may be calculated from  $I^2R$ . For 50-ohm coax, 50 watts will show 1A; 200 watts, 2A and 1 kW almost 4.5A. The size of the meter will therefore depend on the power to be handled. You will find that, so long as the reflected power is zero and the coax between transmitter and coupler is short (say 6 feet or so), this power calculation will be quite accurate.

### matching the antenna

We now come to the reason for a possible inability to obtain a match at some point on the 14 MHz band. The first point we must remember is that the coupler has *not* reduced the standing waves on the feeder, nor done anything to improve the match between antenna and feeder; it has merely cancelled feeder reactances by resonating the feeder.

There is one well-known fact about a resonant feedline (whether it be resonated to a half wave or a multiple of a half wave) and that is that the value of its terminating resistance will be accurately reflected back to the power source. In the case of the three-band beam, with an average radiation resistance of 50 ohms, we see something very near to 50 ohms at L1C1 in most cases. The Z-match will permit a slight impedance transformation by varying C1 against C2, and as a result, we are able to present an accurate 50-ohm match to the transmitter over the whole of the 21- and 28-MHz bands and over quite a large portion of 14 MHz. The impedance transformation of the coupler is, however, limited. You may reach a point where it is no longer possible to obtain sufficient transformation and a true impedance mismatch results.

Let us suppose that the antenna is presenting a radiation resistance of 200 ohms. Even with reactances cancelled, L1C1 sees 200 ohms, but L2C2 requires 50 ohms. The coupler struggles to effect transformation, fails to do it completely, and the transmitter is underloaded.

On the other hand, suppose the radiation resistance falls to 20 ohms. Again, the coupler struggles to transform 20 to 50, but just cannot do the job, and the transmitter is overloaded.

In either of these cases, we have a mismatch which shows up at the swr bridge, and is seen as either an excessive or insufficient current in the rf ammeter. We can, of course, tell whether the antenna is showing a low or a high radiation resistance by the ammeter.

In point of fact, a three-band beam is likely to show a very low radiation resistance at its resonant point. This is usually offset by making the feeders somewhat longer than a half-wave at this frequency in order to obtain some feeder transformation.

Whether it is worth trying to vary the feeder match at the antenna is debatable, because we may upset the match at all other frequencies by doing so. Perhaps we should accept the fact that we have a slight mismatch and let it go at that. However, we should not lose sight of the fact that we have the tool to do the job of matching. Recall that with the coupler, we may terminate the coax in a dummy load instead of the antenna and adjust everything until we have a perfect balance. If we now reconnect the antenna and vary the match, without moving anything else, the swr bridge will tell us when we have made the match.

The important thing here is that the bridge will tell the truth! In the case of a bridge in the main coax line, any slight standing wave on the coax will upset the bridge and any slight change in coax length or in the placement of the bridge along the coax will produce misleading results. We need to isolate the bridge from the main feeder if we are to obtain accuracy—and this is where the coupler comes in.

The routine adjustment of the coupler is simple, provided you made reset marks for C1 and C2. If the capacitors are set to their marks, the transmitter is tuned and loaded for maximum forward current at the bridge (or at the rf ammeter) and C1C2 is then trimmed until there is zero reflected current. As a rule, the bridge should be left to read reverse current, and as the transmitter is moved around in the band, any rise on the meter should be compensated by adjustment of C1.

## summary

With the bridge to warn of any rise in swr, you will find that, at any frequency in any band, the transmitter will draw its rated power. Although there will still be some standing waves on the feeders producing feeder losses, these losses are a percentage of the available power and, therefore, any improvement in available power will improve the radiated signal.

Remember, what holds true for transmission also applies to reception. If harmonic radiation is down 30 dB, then the coupler will attenuate incoming signals which are not in the chosen band. When changing bands on the receiver, do not forget to switch the coupler or the band may appear to be dead.

On the subject of harmonics, we should remember that a three-band beam, by its very nature, will accept 28 MHz with the same facility that it accepts 14 MHz; there is no attenuation of the second harmonic of 14 MHz. Moreover, any dipole will accept some power on its harmonics and a three-band affair is likely to radiate the second harmonic of 21 and 28 MHz. With the coupler in use, the antenna is no longer able to load on more than one band at a time because of the filtering action of the two tuned circuits.

## acknowledgement

Thanks are due to ZS6YK for his suggestion that he needed a coupler, for his suggestion of the rf ammeter and for his painstaking testing of the experimental unit which has now been incorporated into his station.

ham radio

# loading the mobile transmitter

Sound information  
on overcoming  
the problems  
frequently faced  
in loading  
mobile rigs  
into the  
less-than-ideal  
antenna

**At one time or another**, nearly every ham has had trouble loading his mobile rig. The following is a review of some of these problems and what may be done to correct them.

What is proper loading? Proper loading could be defined as the condition under which you are able to obtain satisfactory plate current readings at the settings of the power amplifier tuning and loading

controls specified by the manufacturer. For example, the Collins KWM-2 has a section of the final amplifier tuning control marked for the various bands and the load control has a spot marked *50 ohms*. The Heath HW-22 instruction book says loading will be proper when the final amplifier resonates in the middle third of the dial range. If the manufacturer does not specify the approximate locations of these controls, I suggest you connect a 50-ohm dummy load to the transmitter, load the final amplifier to the recommended plate current, and record the dial settings. This should be done on all bands. Whenever the antenna is connected to the rig the final tuning and load controls should be in about the same places as for the dummy antenna. A large deviation means the antenna presents a load too far removed from the optimum non-reactive 50 ohms for proper operation.

## impedance

If our mobile antenna does not load like the dummy antenna, or if the transmitter will not tune satisfactorily as recommended by the manufacturer, then the antenna must be adjusted. Further proof of this may be obtained by substituting the 50-ohm dummy load for the antenna at the antenna end of the 50-ohm transmission line. The transmitter should return to normal regardless of the transmission line length. Our job is to

Stark Totman, W4YB, Box 912, Stuart, Florida 33494



make the antenna termination look like the 50-ohm dummy antenna. This takes real work since the radiation resistance of a base-fed quarter-wave antenna is about 35 ohms when operating over a perfectly conducting ground. Obviously, we rarely have a perfectly conducting ground. In fact, we rarely have the optimum mounting recommended by the antenna manufacturer. Should the optimum ground prevail, there is an interesting chart in an article by W0JF which shows that 50 ohms can be obtained by making the antenna slightly longer than for resonance.<sup>1</sup> However, this makes the termination reactive. In other words, we have 50 ohms but it is not like our non-reactive dummy load. This will probably show up by our transmitter not tuning properly — particularly the final amplifier will not resonate in the correct spot. To correct this condition, place a small capacitor at the antenna termination to balance out the inductive reactance, and a 50-ohm resistive termination will result. Phil Rand, W1DEM, says he carries along several mica capacitors ranging in value from 50 pF to 0.002  $\mu$ F for this purpose.<sup>2</sup> He uses the smallest one necessary to provide proper operation. Kayla Bloom Hale, W1EMV, goes Phil one better when she mounts a rotary switch at the base of her mobile antenna and permanently installs capacitors for each band.<sup>3</sup>

## swr

I have not mentioned standing waves or reflected power because it can usually be said that if the transmitter loads properly then the swr is within tolerance. But what is tolerance? Many of our transmitters — particularly high-power linear amplifiers — are designed for no more than a 2:1 swr. This, then, determines the tolerance. W1DBM says a 5:1 swr is hardly worth worrying about on 4 MHz as far as loss is concerned, but many transmitters are not designed to compensate for this condition, therefore it is well to use a meter to get the swr down as low as possible by using the capacitors and adjusting the antenna. He also points out

that with a higher swr, transmission line lengths become important. The reason for this is that the impedance varies with the line length. This impedance is determined by the voltage and current at each particular spot on the line. For example, in a properly terminated 50-ohm line, we could have 100 volts and about 2 amperes of rf at the transmitter running 200 watts output. At the antenna end we would have the same thing, assuming no loss in the line. However, if the antenna were so adjusted that a 12.5-ohm impedance was presented to the line, we would have a 4 to 1 mismatch, and we would also have a 4:1 swr. Theoretically, depending on the line length, this could result in an impedance between 12:5 and 200 ohms, resistive, capacitive or inductive, at the transmitter end. It might be possible to come up with a length of line that would be close enough to 50 ohms, at some specific frequency, for the transmitter to load satisfactorily. However, more than likely, it would fall somewhere between the maximum and minimum values at a point where the transmitter would not load. If we happened to have a half wavelength of line (electrically), then the impedance presented to the transmitter would be the same as at the antenna. Such a length is not normally considered desirable.

## reflected power

Normally, reflected power is not lost. If the transmitter is capable of loading properly into a line of high swr, it will be found that nearly the same power is delivered to the mismatched load as to the matched load. Carl C. Drumeller, W5JJ, demonstrated this when he substituted a load of one quarter the terminating resistance, resulting in a 4 to 1 mismatch.<sup>4</sup> When the transmitter was loaded to the same power input for both terminations, the total wattage in the load was very nearly the same. The current in the lower resistance had nearly doubled which, when applied to the current squared times resistance formula, came up with the same power. This again bears out the fact that if the transmitter

has the capability of loading into wide variations of load impedances, then the swr is not so important. What does happen with high swr is a tendency for loss in the transmission line caused by heat or dielectric loss at the points where high currents or voltages occur. Many hams use antenna tuners to tune a line so it will present 50 ohms to the transmitter. This is an excellent device. However, only that part of the line between the tuning device and the transmitter is flat. This system is used frequently with a balanced line to provide all-band operation from one antenna. Depending on the length of the antenna and the frequency, the swr on the line between the antenna and the tuning unit can be extremely high. The fact that these antennas make excellent radiators will again show that, even under these conditions, the indicated reflected power in that portion of the line between the antenna and the tuner is not lost. W5JJ says this about reflected power in his experiments: "In each instance, this power is fictitious, properly measurable in terms of 'volt-amperes reactive' instead of true 'or work-producing' watts."

### fixed operation

Most mobile antennas, 10 meters and

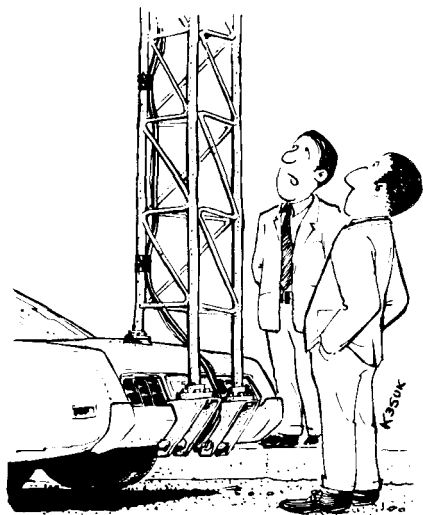

"I'll betcha a steak dinner  
that he's not married."

above, approximate an electrical quarter wave. You can generally say that an antenna less than a quarter wave physically is less efficient than a full quarter wave. This can be dramatically illustrated when going from a 75-meter loaded whip to a full quarter-wave wire of about 60 feet. Even a low 60-foot wire will be found to be far superior. This is no reflection on the mobile antenna design; an eight foot antenna just cannot be expected to compete with one 60 feet long on 75 meters. Also, the maximum radiating portion of an antenna is considered to be that part which has the highest current. With a center-loaded whip, this occurs between the base and the loading coil. It is unfortunate that this part of the antenna is frequently shielded by the car body. When the car is parked or when operating from a trailer, for example, it is possible to connect a 60 foot wire (length adjusted for best swr or optimum loading) at the base of a mobile whip for 75 meters and place a resonator for another band on the whip. This gives you a two band system. Other combinations can be worked out such as 75- and 40-meter quarter wave wires and a 20-meter resonator for three bands. However, contrary to the article by W3HTF, these wires must be connected at the bottom of the whip.<sup>5</sup>

### summary

In conclusion we might summarize as follows:

1. Know where the final amplifier tuning and loading control should be for the proper plate current recommended by the manufacturer when the transmitter is fully loaded to a 50-ohm resistive load.
2. If possible use a length of transmission line that is not a multiple of an electrical half wave at the frequencies most used.
3. Adjust the antenna so that the transmitter will load according to manufacturer's specifications. Use an swr meter to assist you, as lowest

reflected power and normal transmitter tuning and loading will usually occur at the same place. If satisfactory results can not be obtained add capacitors at the antenna base and retune the resonator or loading coil.

4. Remember that proper transmitter operation is what we are after. It is conceivable that if the transmitter loads and tunes from a widely divergent spot from optimum, some of the power being radiated could be harmonics. This would make the swr meter read incorrectly since it is *not* a frequency-sensitive device.

5. Once you have your transmitter operating properly, do not be influenced to make a change because someone else uses a different length of transmission line! Remember, he has tuned his antenna to match his particular line length and antenna installation. Merely duplicating his line length will probably not help you unless you go through the complete retuning of your antenna system.

6. Mobile quarter-wave antennas are designed to be operated with the base on the car body or close to it. Most verticals of all types — with and without traps — are made to operate with radials or on the ground. Placing the mobile antenna very far above the vehicle on a pole will make it very difficult to tune unless you want to attach radials at the base of the actual antenna.

#### references

1. Yardley Beers, W0JF, "Short Antennas for the Lower Frequencies, Part I," *QST*, August, 1970, page 26.
2. Philip S. Rand, W2DBM, "Antennas for Travel Trailers and Campers," *QST*, March, 1969, page 34.
3. Kayla Hale, W1EMV, "Variable-Impedance Mobile Mount," *73*, February, 1970, page 96.
4. Carl C. Drumeller, W5JJ, "The Mismatched RF Transmission Line," *73*, November, 1969, page 28.
5. Herman Lukoff, W3HTF, "Improved 75-Meter Portable Performance for a Mobile Station," *QST*, April, 1970, page 24.

ham radio

# YOU ASKED FOR IT!

**HERE IT IS!** . . . one complete U.S. Callbook and one complete DX Callbook per year and no change in price. In addition you can keep your CALLBOOKS up-to-date through a subscription to the new Service Edition Series published each March 1, June 1 and September 1 — each one covering new licenses and all activity during the preceding quarter. Annual subscription to complete Winter CALLBOOKS plus 3 Service Editions only **\$14.95** postpaid for the U.S. and **\$11.45** postpaid for the DX.



These valuable EXTRA features included in both editions!

- QSL Managers Around the World!
- Census of Radio Amateurs throughout the world!
- Radio Amateurs' License Class!
- World Prefix Map!
- International Radio Amateur Prefixes!
- Prefixes by Countries!
- Zips on all QTHs!
- A.R.R.L. Phonetic Alphabet!
- Where To Buy!
- Great Circle Bearings!
- International Postal Information!
- Plus much more!

See your favorite dealer or order direct (add 25¢ for mailing in U.S., Possessions & Canada. Elsewhere add 50¢).

**50 YEARS OF SERVICE TO RADIO AMATEURS**  
**GET YOUR NEW ISSUE NOW!**

**WRITE FOR FREE BROCHURE!**



**callbook** INC  
Dept. E 925 Sherwood Drive  
Lake Bluff, Ill. 60044

# measuring coaxial-line loss with a reflectometer

Here is  
a simple technique  
using an ordinary  
reflectometer  
and the  
station transmitter  
to determine losses  
of new and used  
coaxial lines

Milton Dexheimer, W2YCI, 91 Linwood Avenue, Tonawanda, New York 14150

Coaxial lines deteriorate over a period of time, especially when they are exposed to the weather. Periodic checks should be made to determine whether or not the line attenuation has increased to the point where the coax line needs replacement. This is especially true of vhf where line losses normally run higher and where line losses drastically affect both transmitting and receiving. An increase in coaxial-line loss results in a lower vswr at the transmitter when the reflected voltage is reduced by the line attenuation, so the amateur is often unaware of increasing line losses until he starts wondering why he hasn't been hearing and working those DX stations.

The coax feedline must be disconnected from the antenna to make this attenuation measurement, and some provision must be made for shorting the inner conductor to the shield at the end of the line which previously connected to the antenna. A coax connector at the end of the line and a coaxial short are desirable, especially at vhf, but careful soldering of the center conductor to the braid with as short a lead as possible will suffice.

Make several measurements with an

ohmmeter before making the reflectometer measurement. This assures that the coax is not shorted or has an open shield. A short or open circuit condition indicates a bad coaxial line which would not be detected by the reflectometer test. The coax should be immediately discarded if it fails either of these tests. To check for shorts, leave the far end of the coaxial line (antenna end) open and connect an ohmmeter, set to the highest resistance scale, between the center conductor and the shield of the coax.

An open circuit (infinite resistance) should be indicated on the ohmmeter. If the coax passes this test a coaxial short should be placed at the end of the line, and the resistance of the shield and center conductor measured with the ohmmeter set to the lowest resistance scale. This resistance will vary with the type of coax used and the length of the line, but for practical purposes the resistance will be less than one ohm for lengths under 100 feet. An open-circuit or high-resistance indicates that the shield has deteriorated or that the center conductor is open, making the coax useless.

If the coax passes the short and continuity tests, proceed to check the actual loss in the coax at radio frequen-

**Equations:**

1.  $p = V_r/V_f$
2.  $dB = 20 \log V_f/V_r$
3.  $V_f/V_r = 1/p$
4.  $dB = 20 \log 1/p$
5.  $p = (1 - vswr)/(1 + vswr)$
6.  $vswr = (1 + P)/(1 - p)$

transmitter worked very well for measurements at my station.

In the forward position the reflectometer will read the forward or input voltage to the coax ( $V_f$ ). This should be adjusted for a full-scale reading, making sure that the far end of the coaxial line is shorted. In the reverse position, the reflectometer will read the reflected voltage ( $V_r$ ). This reflected voltage is the input voltage attenuated by the coaxial loss, reflected at the shorted end of the coax, and attenuated again by the coaxial loss between the short and the reflectometer.

The ratio of the reflected voltage to the forward voltage is the reflection coefficient ( $p$ ) as noted in the following equation:

$$p = \frac{V_r}{V_f} \quad (1)$$

The ratio of the forward voltage to the reflected voltage is used in equation 2 to

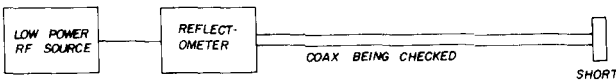

fig. 1. Block diagram of the test setup for determining coaxial line losses with a reflectometer.

cies using a reflectometer in conjunction with a low-power rf source connected as in the block diagram, fig. 1. Since losses increase with frequency, the coax should be checked at the highest frequency at which the coax is to be used. The low-power rf source may be a low-power transmitter (5 to 25 watts) loosely coupled to the reflectometer, or the driver stage of a higher powered transmitter link coupled into the reflectometer with a small coupling loop at the end of a short length of coax. Link coupling into the driver stage of a 100-watt two-meter

determine the attenuation in decibels. Equation 1 may be rewritten to express the ratio of the forward voltage to the reflected voltage as the reciprocal of the reflection coefficient as noted in equation 3. Substituting  $1/p$  for  $V_f/V_r$  in equation 2, we now have the attenuation of the coaxial cable in terms of the reflection as indicated in equation 4.

Thus, the loss in dB can readily be determined by measuring the reflection coefficient of the shorted coaxial line. Remember that this represents the loss going down the line as well as coming

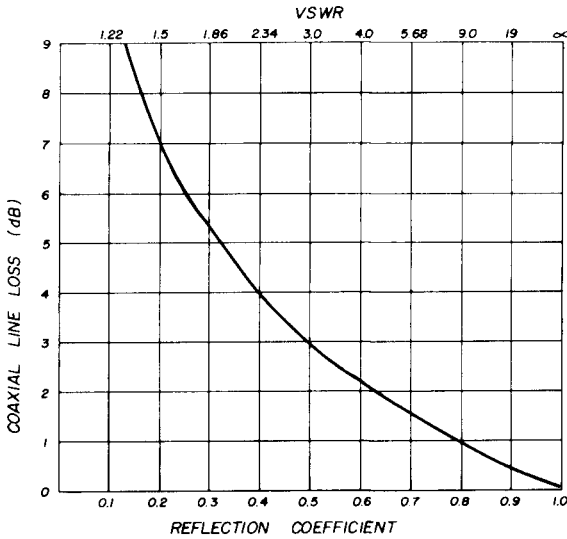

fig. 2. Coaxial line loss is read in dB at left at the point of intersection of the curve and the reflection coefficient.

back, thus the attenuation figure must be divided by 2 to find the actual coax loss. If the reflectometer meter scale reads vswr directly, use **equation 5** to determine the reflection coefficient and proceed as before.

### example

As an example, consider a coax line which presents a reflection coefficient of 0.5 when shorted on the end of the line. Using **equation 6**, this represents a standing-wave ratio of 3:1. Using **equation 3**, the ratio  $V_f/V_r$  is equal to 2. The two-way coax attenuation is next determined using **equation 2**.

$$\text{dB} = 20 \log 2$$

Since the  $\log$  of 2 = 0.3, the attenuation is 6 dB, and the actual line attenuation is 1/2 of this value, or 3 dB. This may also be determined from the graph by drawing a vertical line at  $p = 0.5$  on the lower horizontal scale denoting reflection coefficient. Note that this line also crosses the upper vswr scale at 3.0:1. Draw a horizontal line where this vertical line crosses the curve and the point where it intersects the left vertical scale indicates the actual coax line attenuation, 3 dB.

After the coax loss has been measured, the normal loss should be determined to

compare with the actual loss measured. **Table 1** lists the attenuation loss in dB for several types of coax at several frequencies. Remember that the attenuation is proportional to the length of coaxial line used and increases with frequency. The attenuation of a 50-foot length of coax will be one half the attenuation of a 100-foot length.

table 1. Coax loss per 100-foot length (dB).

	28 MHz	50 MHz	144 MHz	220 MHz
RG-8/U	1.1	1.33	2.8	3.5
RG-11/U	1.3	1.59	2.85	3.25
RG-58/U	2.5	3.13	5.8	6.9
RG-59/U	2.0	2.4	4.25	4.85

Measurements should be made on several new lengths of coaxial line to properly check out the test circuit and technique. If the results are in question, the coaxial short may be placed at the reflectometer output, where the reflection should be 100%, giving a reflection coefficient of 1. A reading less than this indicates a need for reflectometer adjustment. With reasonable care, the attenuation of coaxial lines of 50 feet or more may be determined with fairly good accuracy.

ham radio

# New digital readout



**New Heathkit SB-650 Digital Frequency Display... another "first" from the hams at Heath.** **179<sup>95</sup>\***

- Resolution to within 100 Hz  $\pm 1$  count
- Compatible with all Heathkit SB Receivers and SB and HW Multiband SSB Transceivers
- Six bright readout tubes display MHz, kHz and hundreds of Hz
- Easy operation—80-10 meter coverage with no bandswitching required

You asked for it and Heath produced it. An exciting piece of ham gear to bright-light frequencies... readable from up to 30 ft. away. The new SB-650 digital frequency display reads the three frequencies of a heterodyne circuit; then computes and displays the actual signal received or transmitted. All within a tight 100 Hz accuracy. Six bright digital readout tubes show you exactly where you are as you tune across the 80 through 10 meter bands, from 3 to 30 MHz. The SB-650 lets you read kHz to five places...plus tenths of a kHz.

And talk about compatibility. The SB-650 is designed to team up with all Heathkit SB-Series Receivers and Heathkit SB- or HW-Series Multiband Transceivers. When it's in combo with a transceiver, the "650" calculates and displays both transmitted and received frequencies. To make installation easier, the SB-650 manual fully describes and illustrates all inter-connections necessary for the specific Heath gear you own.

Your SB-650 assembles in just four to five hours. Its 35 ICs and the display tubes plug into sockets

on the double-sided glass epoxy board. And there are no tuned circuits, only four easy internal adjustments are needed to get your "650" peaked up and ready to go.

The SB-650 Digital Frequency Display. Its got to be one of the most "up-and-coming" pieces of ham gear ever offered. Its another trend-setting "first" you can count on... from the hams at Heath.

**Kit SB-650, 9 lbs. .... \$179.95\***

**SB-650 SPECIFICATIONS** — Frequency range: 3-40 MHz (80-10 meters). Frequency Display: 6 display tubes (kHz to 5 places, plus tenths of kHz). Maximum Viewing Distance: 30 ft. Maximum Input Signal: 5v rms. Accuracy: 100 Hz  $\pm 1$  count. Compute Time: 160 msec. Sensitivity: Adjustable. Input Impedance: 2000 ohms. Internally Generated Spurious Frequencies: Approx. 0.25  $\mu$ V equivalent signal level. Crystal (clock) Frequency: 1 MHz. Crystal Aging Rate: Approx. 10 ppm/yr. Ambient Crystal Stability: Approx. 10 ppm from +10 to +65° C. Ambient Operating Temperature: 0° - +40° C. Ambient Storage Temperature: -55° to +80° C. Power Source: 120/240 VAC, 50/60 Hz, 10 W. Dimensions: 3½" H x 10" W x 10" D.

HEATHKIT Schlumberger	
HEATH COMPANY, Dept. 122-5 Benton Harbor, Michigan 49022	
<input type="checkbox"/>	Enclosed is \$ _____, plus shipping.
	Please send model(s) _____
<input type="checkbox"/>	Please send FREE Heathkit Catalog.
	Name _____
	Address _____
	City _____ State _____ Zip _____
Prices & specifications subject to change without notice.	
*Mail order prices; F.O.B. factory. AM-267	

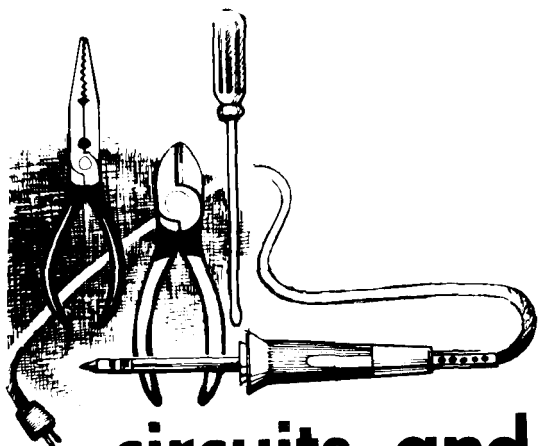

# circuits and techniques

ed noll, W3FQJ

## antenna potpourri

Here is still another configuration for those of you who have become enthusiastic triangle experimenters. This triangle is open at the top (apex) to attain a low-impedance feed point at the center of the base, **fig. 1**. By so doing, the antenna is divided into two three-quarter wavelength segments and a resultant low-impedance feed. In the broadside direction there is a gain improvement over the full-wave closed triangle. The antenna impedance is about 200 ohms at resonance, and a broadband match can be attained with a 4-to-1 balun. A tee-network tuner also functions well. In the latter case a 40-meter version of the three-half wavelength triangle also performs well on 15 meters where it can be matched to operate as a nine-half wavelength open triangle. I recently erected a 40-meter version. (**fig. 2**) of an antenna I had previously checked successfully on 10, 15 and 20 meters. The basic three-half wavelength equation would be:

$$\text{length in feet} = \frac{1476}{f(\text{MHz})} = 206'$$

Therefore, approximate length for reson-

ance near the center of 40 meters would be 206 feet (two 102-foot segments). In practice the band-center resonance was obtained by clipping back about 5 feet on each side. This corresponds to a shortening of about 5%. The amount of shortening will vary with the height of the triangle's base above ground and the apex angle of the triangle. First cut for formula length and then shorten. The swr figures, when using a 4-to-1 W2AU balun, are also given in **fig. 2**.

### triangle advantages

The advantages of triangle antennas are good performance at low cost, single mast erection, transmission line need only be run to the base of the triangle and not up the mast, feed ends of the line are readily available for trimming and matching, directional pattern can be shifted from ground level simply by swinging the triangle corners around to other pairs of metal fence posts that act as supports for the base of the triangle and the vertical angle can be changed easily.

### tilt angle experiments

The tilt angle of the triangle plane can be changed conveniently by moving the metal fence posts which support the base corners of the triangle. The vertical angle is lowered by moving the base of the triangle toward the preferred direction. In tests, the most favorable tilt for late-night reception from Europe was about 15°.

Test procedure was unique and

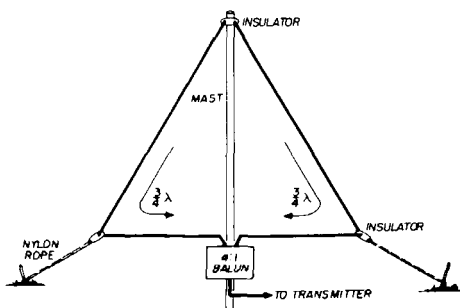

**fig. 1. One-and-a-half-wavelength triangle antenna.**



economical—I used those pesky foreign broadcast stations on 40 meters. A comparison antenna was a full-wave 40-meter wire, sloped toward Europe. These tests made one significant impression: the vertical angle of the receiving antenna has a definite influence on the signal de-

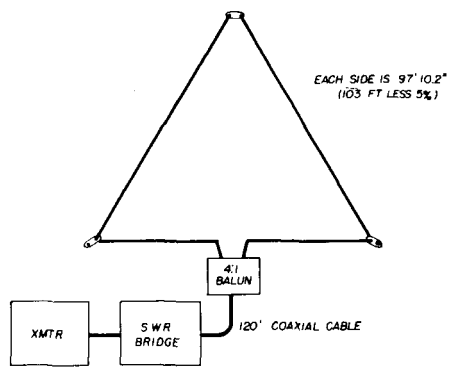
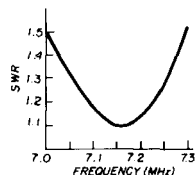

fig. 2. Forty-meter 3/2-wave open triangle antenna with swr curve.



livered to the receiver input. Furthermore, that preferred angle is not a constant. In one test session with the triangle in a vertical position, the early evening reception on the triangle was better than the sloping wire. Much later the same night, stronger signals were being delivered by the sloping wire.

All of this might indicate that even in the case of the popular sloping dipole used widely for low-band DXing, a remote means of changing the height of the low side of the dipole may be of definite help in establishing a favorable angle for the propagation conditions of the moment. The influence on 80 and 160 meter low-angle performance could be important. You can gain experience on 40 meters by using the foreign broadcast stations as test signals.

Tilting a triangle in the preferred

direction lowers the vertical angle. At the same time the vertical angle is raised to the rear.

### more low angle

The subject of low-angle radiation was treated at length last year by Pat Hawker, G3VA.<sup>1</sup> He mentioned that during poor conditions on the North Atlantic path the vertical angle of radiation should preferably be below 2.5°. Certainly these conditions will prevail during minimum sunspot and it may be that the very popular beam antenna of today will not be the one that does the best job during minimum sunspot years. Ground interference can have an adverse affect on the vertical patterns of such antennas. Also important is the matter of obtaining effective height; that is, at least one wavelength above ground.

Pat also mentioned the attractive characteristics of sloping antennas and the use of verticals to obtain low-angle radiation. Dipoles, vees and rhombics can be sloped to obtain low-angle radiation at moderate antenna height.

The article states that the sloping-V antenna, fig. 3, has been neglected. Only a single high mast is needed with the antenna ends dropping to near ground level. A good unidirectional pattern and broadband performance is obtained using 600-ohm terminating resistors. Transmission line can be tapered from a high of about 800 ohms to the several hundred ohms of one of the common types of

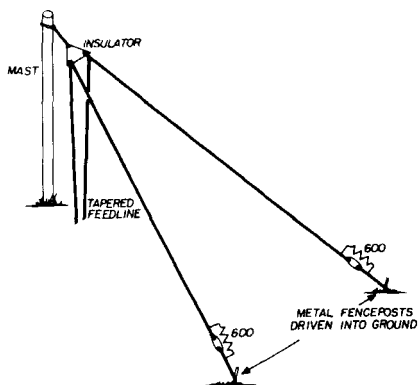

fig. 3. Sloping V-beam antenna.

open-wire transmission line. An alternative is to taper the line down to about 200 ohms and use a 4-to-1 balun to match and transform the antenna system to a coaxial transmission line. One of the favorable characteristics of sloping rhombics and sloping vees often overlooked is their broadbandness as compared to strictly horizontal versions. This is attractive in terms of multiband amateur operations.

### umbrella antenna

An interesting article by James K. Palmer concerned the umbrella antenna, an elaboration of the inverted V.<sup>2</sup> Inverted V segments cut to various frequencies are spaced equidistantly about the single mast of the antenna system. A typical model operating between 4 and 30 megahertz with a maximum swr of only 1.5 to 1 consisted of 10 dipole antennas (20 elements) cut for frequencies of 4, 7, 10, 15, 18, 21, 23, 27, 29 and 30 megahertz.

I have used a similar maypole construction successfully on the amateur bands, although not as many elements were used.<sup>3</sup> One was a 15-, 40-, 80-meter dipole combination for Novices and the other was a 20-40-80 combination for

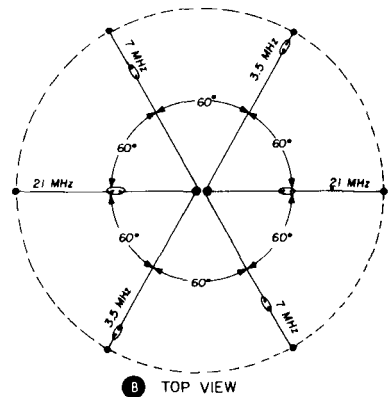
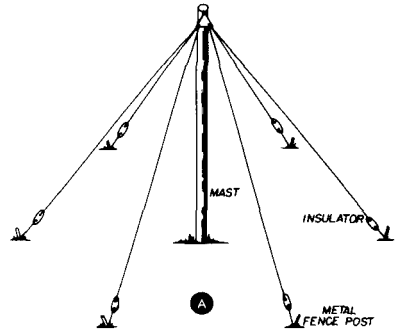

fig. 5. Construction of the Maypole antenna.

side-band operation, fig. 5. However, there is no reason that the idea cannot be expanded into a good broadband, all-band antenna with low standing wave ratio.

### yagi arraying

One of the most exciting possibilities for amateur operations can be anticipated from the very fine and detailed Yagi article by James Emerson.<sup>4</sup> One of the most trying problems in providing a high-quality community antenna television system (CATV) is co-channel and adjacent channel interference. These are also some of the biggest problems in amateur radio reception.

Most CATV receiving stations use Yagi or log-periodic antennas. They often use them in pairs or bays to increase receive gain. Sometimes the pairs or bays are appropriately phased to reduce co-channel or adjacent channel interference.

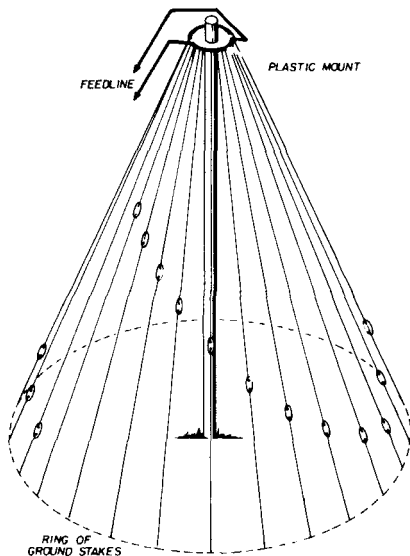

fig. 4. Umbrella antenna.

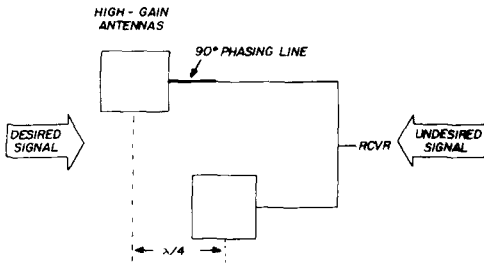

fig. 6. Reducing undesired signal pickup by properly phasing high-gain antennas.

One of the most obvious results of the technique would be the reduction of the signal level of a more distant television station on the same frequency that enters the back of the antenna. With the use of two phased antennas there results a considerable improvement in the front-to-back ratio above the basic front-to-back of the basic antenna configuration. This possibility is shown in fig. 6. Note that one antenna (a Yagi or other type) is positioned  $90^\circ$  ahead of the other. Furthermore, there is a  $90^\circ$  phasing line attached to this antenna before it reaches the combining receptacle. The net result is that a signal arriving from the back introduces a signal into the two Yagi's which cancel out at the combining point. The use of two Yagis, so phased, can do a fine job in cutting down the back pickup (pesky short-skip interference).

It is indeed fascinating that a proper two-Yagi combination can even cut back on interference arriving from the front provided that its angle of arrival is more than  $5^\circ$  away from the angle of the desired signal, fig. 7. Of course, a

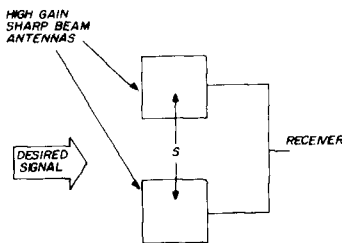

fig. 7. Reducing signal pickup from the front and sides of the antenna. Distance S determines the angle of the nulls.

basically high-beam and sharp-beam Yagi must be employed. Two such Yagis are mounted side by side (broadside). Proper adjustment of the spacing between the two Yagis can be used to locate the pattern null in the direction of the undesired-signal angle. For example, two such sharp beam Yagis separated by one wavelength will produce sharp nulls at 30 and  $330$  degrees.

Calling all antenna experimenters! What about the possibility of two separately rotatable Yagis (or perhaps three mounted in a triangle) as an effective anti-interference arrangement? In the simplest arrangement perhaps only one

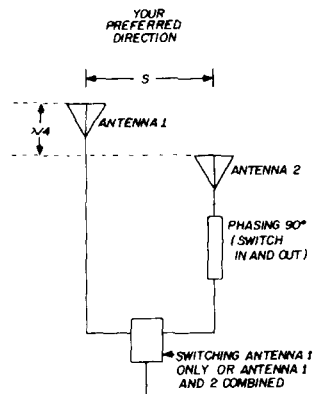

fig. 8. An amateur-band ultimate. Choose distance S wisely for your area.

need be used as a transmit antenna. The second one could be switched in, fig. 8, on receive only. It would be separately rotatable and would be rotated to obtain a null on an interfering station.

### references

1. Pat Hawker, G3VA, "Technical Topics," *Radio Communications*, April, 1971, pages 263-265.
2. James K. Palmer, "The Umbrella Antenna: An Inexpensive Broadband Omnidirectional Antenna," *Communication News*, June, 1971, page 52.
3. Edward M. Noll, W3FQJ, "73 Dipole and Long-Wire Antennas," Howard Sams, Indianapolis, Indiana, 1971, pages 23-27.
4. James Emerson, "Arraying Yagi Antennas For Positive Results," *Broadcast Engineering*, May, 1971, page 32.

ham radio

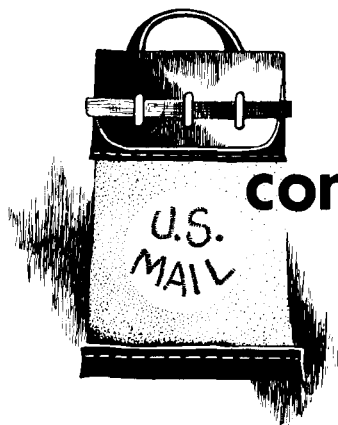

## comments

### triangle antennas

Dear HR:

I have constructed two of these antennas, one for 20 meters and one for 40 meters. The results on 40 meters have been outstanding, both on receive (low noise) and transmitting. On-the-air tests compared to an inverted vee at the same height ran from 1½-S units to *quote*, "Just like turning on a linear."

I wanted to try this antenna on 75-meter ssb, but since I didn't have a pole high enough or a city lot wide enough, I tried adding to the 40-meter triangle with very good results. See fig. 1.

By clipping on two wires approximately 40-feet long at the corners of the triangle and adjusting the length, it tuned up on 3925 kHz. To return to 40 meters, I just unclipped the wires. These 40-foot wires could not be placed in the same plane as the antenna (due to space limitations), but were connected at the corners with an angle of slightly more than 90°.

The wires were connected at a height of ten feet at the triangle corners and six feet at the far ends. For a short test the wires were stretched in the same plane as the triangle and no difference was detected. The swr on both 40 meters and 80 meters was the same, 1.05:1; the antenna was broadly resonant between 3800 and 4000 kHz. Relays could be used or maybe traps (*horrors*), to make an excellent two-band antenna.

I used the antenna formula  $(984/f_o) = \lambda$  and ended up too high in frequency and outside the band (using number-14 enameled wire). I found that  $(995/f_o) = \lambda$  came out better in my case. Why? Could it be the plastic covered wire in your case and the enameled wire in my case?

L. Showalter, W6KIW  
Petaluma, California

*I've always been impressed with the results of the triangle. Your manner of obtaining 80-meter resonance is quite novel, and I hope to give it a try. I want to add that the triangle need not be equilateral (three equal-length sides), and you probably could erect an 80-meter version with your present pole.*

*Three factors affect resonance and impedance. These are apex angle, height above ground in wavelength and any beneath-ground radial system you may use with it. Like an inverted-vee, more length is needed to resonate on a given frequency as the apex angle is decreased. It has been my experience with an inverted-vee that the best low-angle DX results are obtained off the wire ends especially when legs were greater than  $\lambda/4$*

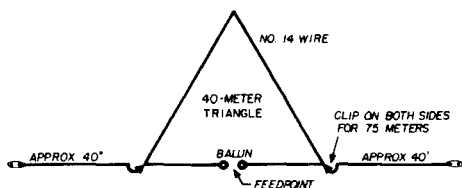

fig. 1. W6KIW's 75- and 40-meter triangle.

*long. However, with triangles, the best results are obtained broadside for short and long skip.*

*It has been a fascinating configuration for me and there is much to be learned. I hope you will continue your experiments and keep us informed.*

Ed Noll, W3FQJ

## laser communication

Dear HR:

It is encouraging that some readers have expressed interest in laser communication. I have taken out some time for optical experiments that have resulted in a first *two-way laser QSO!* It took place on the evening of 12 November 1971 over a path of 3.8-miles—line of sight—using both a 0.5 mW helium-neon and two 7W gallium arsenide heterostructure laser diodes. Voice communication was attempted. However, we had to resort to keying the gallium arsenide laser units on-and-off because the pulse-fm detector circuits did not detect the narrowband fm satisfactorily.

Ralph Campbell, W4KAE

## safer grounding

Dear HR:

I was surprised to read the letter by Keith Olson, W7FS, which appeared in the May, 1971 issue. The driving of ground rods and finding a location with suitable ground conductivity has always been a problem, but why risk your own or your neighbors' health in the process? Mr. Olson recommends filling the pipe with copper sulfate ( $\text{CuSO}_4$ ) once it has been driven down to reach the ground-water level. Anyone who has never worked with copper sulfate might think this to be a good practice, since it has copper in its name, and copper is a good conductor. Copper sulfate, however, is very poisonous and caution should be observed whenever it is used.

If you have ever read the ingredients

listed on the sides of insect spray powders, you have found that many of them contain a compound known as Blue Viriol or copper sulfate, for they are one in the same. One of the most common sprays is the agricultural one known as *Bordeaux*. If this substance is allowed to enter the ground water supply as Mr. Olson suggests, the results could be fatal. In some areas where city water is not available and your source of water is the well in the back yard or under the house, by using copper sulfate you run a very high risk of contaminating your own or your neighbors' water supply.

As a replacement for the copper sulfate, I recommend good old table salt, also known as sodium chloride. In solution, it is a better conductor and will thus make a better ground. It is also cheaper, easier to find and not nearly so dangerous.

Dennis Recla, WA5KTC  
Garland, Texas

## threshold-gate/limiter addition

Dear HR:

A recent article by WB2VXR\* points out that the signal distortion introduced by threshold gating may be reduced by filtering the gated signal. Applying a simple W4NVK filter† to the threshold-gate/limiter circuit presented in the January, 1972 issue of *ham radio* (page 46) was found to give a smoother tone and to place less reliance on pre-gating Q to get an acceptable note. The addition of an 88-mH toroid and a suitable capacitor (0.25  $\mu\text{F}$  in our case) in series with the 8-ohm headset proved to be a worthwhile addition. The Q of this circuit is high enough to reduce distortion, but low enough to avoid ringing problems.

John J. Duda, W2ELV  
Geneseo, New York

\*C. Andes, WB2VXR, Threshold Detectors in a CW Audio Filter, *QST*, December, 1971, page 20.

†E. Dusina, W4NVK, The Simplest Audio Filter, *ham radio*, October, 1970, page 44.

## rome tourist guide

Dear HR:

Since I work in Rome as a tourist guide for American tourists, if American hams come to Rome I can show them around in my car at favorable rates. However, they must notify me well in advance, particularly if they come to Rome during the high season from May through October.

Di Pietro Corradino, I1DP  
Via Pandosia 43  
00183 Roma, Italy  
Tel: 756-7918

## phase-locked loop RTTY terminal unit

Dear HR:

In the phase-locked loop RTTY terminal unit described in the January, 1972 issue of *ham radio*, a simple R-C charging network is used for autostart detection. The positive-going pulses that occur on space are sampled from the output of the detector card. When enough pulses have arrived to develop 1.6 volts across C204, the Schmitt trigger fires allowing current to flow to the Magtrac.\* The Magtrac triggers the SCRs on, turning on the machine motor.

This system works extremely well for on-the-air QSOs and attended operation on some of the MARS RTTY nets. However, it has one drawback: If a CW signal appears on frequency anywhere from the normal VCO resting frequency to the upper capture range limit, the phase-lock loop detector decodes it as a shifted signal. This was quite apparent when I tried monitoring the 14.075, 7117.5 and 3637.5 MHz narrow-shift autostart nets; I would get six inches of garble on the paper from false autostarts caused by a CW signal in the upper half of the phase-lock loop capture range.

The "blank" key provides the greatest space duration of any 60-wpm, five-level RTTY character; the *start* bit plus the five code bits have a total space duration of 132 ms. Thus, any signal with a space

condition greater than 132 milliseconds is not RTTY. Since a normal CW dash is longer than this, by adding a pulse width discriminator to the unit, lockout can be set up on all space signals longer than 132 ms.

In addition, a memory or holding function is necessary to keep the terminal unit output in mark-hold between dashes. This is done with an R-C circuit that has a fast attack and slow release. Another function inhibits any further information from reaching the autostart; if the machine motor is on, it drops out during the normal motor delay time; if the motor is off, it is prevented from turning on. With these additions I had an autostart circuit that was fairly foolproof.

Every time a CW signal is detected, the mark-hold circuit activates for 3.5 seconds. After the last CW character having a dash is sent, the terminal unit returns to an "active" or ready-to-print state after the final delay of 3.5 seconds. This anti-CW function is an absolute must for *unattended* autostart operation. In addition, a SELCAL I output is provided for those operators who use the original SELCAL I electronic calling device. In addition to the normal *force-on* provided at the motor control section, a *force-off* has also been provided to allow the SELCAL I to have absolute control when the teleprinter is in the receive mode.

For complete information on this new, improved phase-locked loop terminal unit, please write to me, Box W, Ham Radio Magazine, Greenville, N.H. 03048.

Ed Webb, W4FQM

## eliminating the matrix in the automatic fist follower

Dear HR:

The article on the Automatic Fist Follower in the November 1971 issue becomes vague when it undertakes to explain, with the aid of fig. 13, the operation of the translator. Even if the

additional 47 circuits in the diode matrix, indicated by fig. 13, contain only seven diodes each, the total would be more than 340. They are probably what caused the authors to say, in commenting on the diode matrix board, "... it's awkward, takes a lot of room, and we wish it wasn't there."

The matrix and its associated ASCII generator are not easy to understand, especially in view of the statement that the ASCII generator is nothing more than six flip flops connected to count from zero to 63 and repeat. For instance, only five lines are shown coming down to the diode matrix with the letter X. How would the translator tell the difference between a dot and a dash on only five lines? And, five lines can only count to 31 when, obviously, 48 counts are needed. On the other hand if, for instance, ten lines are used instead of five—that is, five from the dot register and five from the dash register—and the ASCII flip flops were to count through 63 for each set of lines for each Morse code character, then, although adding diodes, the logic would be easier to understand. With only the five lines there are obviously processes in operation not readily apparent from the figure.

The really hard work in designing the machine, for which the designers should be given no end of credit, was done when the dots were separated from the dashes so they could be placed in separate registers. After that it was only necessary to tag the dashes (or the dots, but not both) in some way so they could be processed as numbers differing in value from those of the dots.

For the character X the dots go into the dot register as null, null one, one, null; i. e. 6. The dashes go into the dash register as null, one, null, null, one; i. e. 9. This is fully explained on page 16 of the text. The sum of the two numbers is 15, but 15 is a number that could identify at least 11 other characters by that logic. Therefore it will not work. Either the dots or the dashes must be tagged.

Tagging an element for this machine is

most easily done by multiplying its binary value by 2. By binary value is meant the position of the elements in a step register translated to binary numbers. If the decision has been made to tag the dashes, then for the letter X, the 9 is multiplied by two in an arithmetic unit following inverter N1, making a new binary number of 18 for the letter X dashes. Added to the 6 for the dots it makes a new number of 24 for the letter X. The 24 can then be placed in a character register for transmission directly to the print wheel where it will match up with its corresponding number as an address on the wheel. Thus the diode matrix and the ASCII generator are eliminated.

Following are the characters identified by the first twenty numbers when developed by doubling the binary value of the dashes.

1 = E	6 = M	11 = D	16 = V
2 = T	7 = S	12 = K	17 = F
3 = I	8 = U	13 = G	18 is blank
4 = A	9 = R	14 = O	19 = L
5 = N	10 = W	15 = H	20 = J

The rest of the Morse code characters can be developed in a like manner. The numeral 9 is 61. The numeral 0 is 62. It should be noted that the first blank number is 18. With 48 numbers being required, 14 numbers will be blank in a six step register. The numbers 0 and 63 cannot be used because of the nature of the Morse code.

In addition to giving a very good clue as to what the diode matrix and the ASCII generator might have been doing they also explain immediately why only five elements of the Morse code are needed to identify a six element special sign. Their last five elements are sufficient for them to fall neatly into one of the blank numbers. This would hold true for any combination of six elements so long as their last five elements did not repeat exactly the five elements of one of the Morse code numerals.

Alf A. Jorgenson, KH6AP

## tape head cleaners

Dear HR:

In the November, 1971 issue of *ham radio* there is a short write-up by K6KA regarding the cleaning of tape recorder heads. Bill recommends Ampex 087-007 Head Cleaner. Since I've had considerable experience with Ampex machines, both commercial wideband and home entertainment, I thought I'd amplify his comments and pass along a warning.

First, most professionals shy away from trichlorethane or carbon tetrachloride, mostly due to their volatile and toxic nature. Alcohol is usually unsatisfactory, since it isn't that good a cleaner and tends to have a drying effect on rubber pinch rollers, causing cracking and flaking of the rubber after extended use.

Ampex Head Cleaner is quite good, but a few precautions are in order. The cleaner is 91% Xylene and 9% trichlorethane. Xylene has one peculiar characteristic: It is an excellent solvent for plastic. Hence, the user must be careful not to spill it on any plastic covers, parts, etc., of the recorder, or they will at least, be marred, and at worst, partially dissolved. In addition, some types of recorders have, in the past, utilized plastic laminate during head construction. Use of Ampex head cleaner on such a head will ruin it in short order! Pure Xylene is far cheaper than the Ampex cleaner, and the only difference is that it is slightly less effective as a cleaner due to the absence of trichlorethane; however, it is perfectly suitable for home applications. Most chemical suppliers can provide it in quart bottles very inexpensively.

Recently, the Navy has dropped most other types of head cleaners in favor of Freon 12 liquid, since it cleans very well, does not attack plastic, vaporizes rapidly, leaves no residue, and is readily available, having already been in wide use for other applications. Commercial cost is unknown, but I suspect that it is fairly low. It can be stored in a sealed glass container at room temperature, and if you spill it, it evaporates in short order, leaving no trace

that anything was spilled. It is far less volatile than other cleaners. As a matter of fact, the Navy even uses it for general cleaning; it is available from Federal Stock in spray cans, so there probably is a commercial equivalent.

A word to the wise on cleaning tape recorders: Don't just clean the heads and let it go at that — clean the pinch roller(s), capstan(s), tape guides, etc., and any other surface the tape passes over. If you clean the heads but not the guides, the tape will pick up loose deposits from the guides and transfer them to the heads, requiring more frequent head cleaning. And don't wait until you lose fidelity to clean the heads, or you'll wear them out much too soon. Heads should be cleaned every 10 hours of operation, or, if transcribing records or other tapes, every time the reel is turned over (or its direction of motion reversed). This ensures the best possible recording quality, and long head life.

I have an Ampex 860, purchased in 1967, with 7500 hours of operation and the original heads are just now starting to show a loss of fidelity. That's 312½ days of continuous, non-stop operation! Says a lot for keeping the heads clean. The average home recorder should wear out before the heads go bad, if properly cleaned.

Paul H. Bock, Jr. K4MSG  
CWO-2, USN

## speech clipping

Dear HR:

*I was pleased to get the reference to the Proceedings of the IRE note by Squires and Bedrosian, since it nicely supports my simplified explanation of why speech clipping and the ssb mode are incompatible. (See my article in HR for February, 1971) I was not aware of the material though I have the Proceedings issue in my collection!*

*Let me start by assuring you that rf (or i-f) clipping is indeed well understood.*



*I believe your difficulty arises from the fact that in the IRE article an infinite bandwidth is assumed. This is why the authors get even worse results for clipped speech in a ssb system than I, because I assumed practical limits for bandwidth (3 kHz) and the lowest audio frequency (400 Hz). An infinite, or to be more practical, a large bandwidth, is a purely relative term and must be viewed against the signal frequency. A 3-kHz bandwidth is indeed nearly infinite when you consider the distortion products or harmonics of a clipped 300-Hz tone. However, a 3-kHz or even a 30-kHz bandwidth is small when you consider a 100-kHz (or 9-MHz) clipped signal.*

*Since the distortion products or harmonics (multiples of the frequency of the clipped signal) are sufficiently filtered out by a single i-f transformer after the i-f clipper, the problem which is causing your concern does not arise. The subsequent mixers and amplifiers are dealing with an amplitude-limited signal without the distortion components.*

*Some time ago, there was a widespread belief that when you filtered a clipped signal so that all harmonics were removed, you got back the unclipped original. This of course is a fallacy; inspection of the Fourier series for a square wave shows that the output variation is 2 dB for inputs between 1 (the clipping level) and infinity!*

*Within the context of your letter, clipping at audio is a special case, since the lower harmonics generated by the clipper fall into the band of interest. Clipping at i-f or rf avoids this through the selectivity inherent in most designs so that there is no phase information to lose. (I agree of course that later mixers are in effect ssb mixers.) For example, when clipping a 300-Hz tone, the distortion products are at 900, 1500, 2100, 2700 Hz etc. When you clip a 100-kHz ssb signal, the distortion terms show up at 300 kHz, 500 kHz etc. Obviously, it is no major task to get rid of these, as the band of interest is still only 3 kHz wide.*

**Walter Schreuer, K1YZW  
Ipswich, Massachusetts**

## freon dangers

Dear HR:

In the July "Comments" column W5PGG said his experience indicates Freon is highly toxic when exposed to high temperatures because it may form phosgene under such circumstances.

I would also like to pass along a warning about Freon, but for a different reason. In my work as a Chapter Director for the American Heart Association, I frequently see research newsletters on investigations sponsored by AHA. The results of a recent investigation of sudden death in kids seeking kicks by breathing aerosol spray fumes, or glue fumes, indicated that they were probably due to heart arrhythmias, that is, abnormal rhythms, such as irregular beat, fibrillation, or complete standstill. In the test, laboratory animals were exposed to strong fields of Freon while their hearts were monitored. The results were those indicated above.

Since Freon is used almost universally as a propellant in every type of aerosol spray, caution is advised. That goes for your wife's hairspray or your tuner cleaner and lube. If it's an aerosol, be sure to use it only in well ventilated areas. The same warning applies to certain types of glue because some of them also contain Freon.

**George Baker, WA5RTB  
Galveston, Texas**

## toroid inductors

Dear HR:

We have read with pleasure W6GXN's interesting and informative article in the April, 1971 issue of *ham radio*. I'm sure this will be a great help to anyone building inductive elements.

I notice the author mentioned our old, "Engineers Aide Handbook," which is long since out of print. Its successor (which is soon to be revised), the "Q Curve Book," is priced at a non-inflationary \$2.50, postpaid.

**R. H. Barden  
General Manager, Micrometals**



# NEW REPEATER

## 2 Meter Fixed Station

Designed for the man who demands professional standards in 2 meter equipment. *REPEATER LINE* fixed station antennas are the 2 meter HAM's dream come true. With everything you need for top fixed station performance...toughness, efficiency and the gain to gain access to distant repeaters with ease. Work many stations, fixed or mobile, without access to a repeater.

The right antennas for the new FM transceivers...or any 2 meter fixed station.

### *REPEATER LINE* Fixed Station Antennas

Tough, high efficiency antennas with a long, low radiation. For the top signal and reception you want...and the top performance your transceiver's ready to deliver.

- 267 Standard 1/4 wave ground plane. May be precision tuned to any discrete frequency between 108 and 450 MHz. Takes maximum legal power. Accepts PL-259. Constructed of heavy gauge seamless aluminum tubing.
- 268 For repeater use. Special stacked 4 dipole configuration. 9.5 db offset gain. 6.1 db omnidirectional gain. Heavy wall commercial type construction. 144 thru 174 MHz. 1.5:1 VSWR over 15 MHz bandwidth eliminates field tuning. Extreme bandwidth great for repeater use. Center fed for best low angle radiation. DC ground. Complete with plated steel mounting clamps.
- 338 Colinear ground plane. 3.4 db gain omnidirectionally. Vertically polarized. 52 ohm match. Radiator of seamless aluminum tubing; radials of solid aluminum rod. VSWR less than 1.5:1. All steel parts iridite treated. Accepts PL-259.
- 362 SJ2S4 high performance all-driven stacked array. 4 vertically polarized dipoles. 6.2 omnidirectional gain. 52 ohm. May be mounted on mast or roof saddle. Unique phasing and matching harness for perfect parallel phase relationship. Center fed. Broad band response. DC ground.
- 340 3 element high performance beam. 9 db gain. Coaxial balun. Special VHF Beta Match configuration. Unidirectional pattern. VSWR 1.5:1. 52 ohm impedance. Heavy gauge aluminum tubing and tough aluminum rod construction.
- 341 8 element high performance beam. 14.5 db gain. Coaxial balun. VHF Beta Match. Unidirectional. Boom length 14'. VSWR 1.5:1. 52 ohm feedpoint. Heavy gauge commercial type aluminum construction.
- 231 15 element high performance beam. 17.8 db gain. Coaxial balun. Beta Match. Unidirectional. Boom length 28'. VSWR 1.5:1. 52 ohm feedpoint. Extra-strength heavy wall commercial aluminum tubing.

# LINE from **Hy-gain** Antennas with real PUNCH!

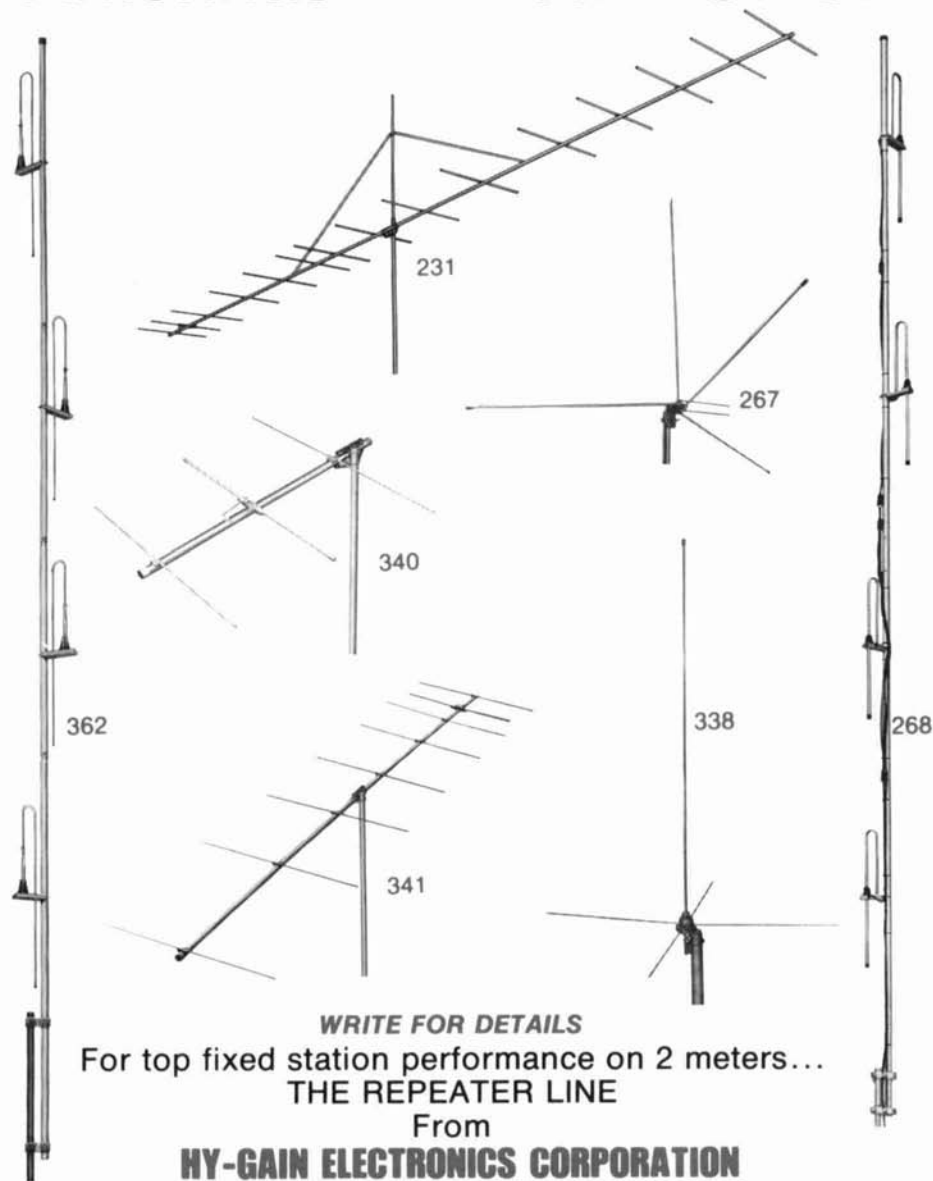

**WRITE FOR DETAILS**

For top fixed station performance on 2 meters...  
**THE REPEATER LINE**

From

**HY-GAIN ELECTRONICS CORPORATION**

BOX 5407-WE LINCOLN, NEBRASKA 68505

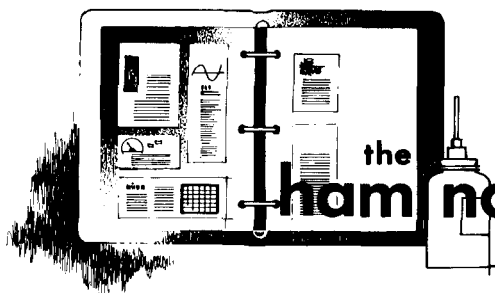

# the ham notebook

## curtain antenna

While planning to erect a 3-element vertical curtain array I found the only available horizontal supporting wire lacked seven feet in height to raise the elements the required distance above the ground. To overcome the problem, I used light bamboo poles to gain the additional element height above the supporting wire. I used number-18 Copperweld throughout to minimize the overall weight of the array. To duplicate my arrangement, select straight bamboo poles and wind the wire in a long spiral around the poles, providing uniform weight loading to keep the poles straight. Secure the wire elements to the poles with a few turns of monofilament fishing line every 9 inches. For protection against the weather, coat the bamboo poles with two coats of marine spar varnish.

Simple rectangles of 5/16-inch sheet plastic shown in fig. 2 insulate and support the 3 elements from the horizon-

tal wire. Light weights at the bottom of the outside (director) elements may be used to maintain the bamboo poles erect. Use only sufficient weight to achieve this result, and at the same time avoid unnecessary loading of the horizontal support wire. Number 18 Copperweld wire is

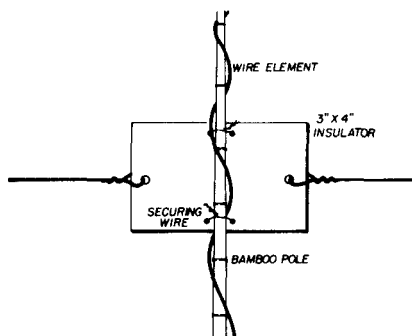

fig. 2. Element supporting insulator details.

rated to support 170 pounds. If the location permits, simply insulate the elements at the bottom and anchor them to stakes driven into the ground.

The array described is bi-directional in the plane of the elements. The middle element is driven from a tap on the tank, which is resonated at the operating frequency. The tank elements should be of the same value and voltage rating as those in the driving transmitter. The dimensions shown were given for 3.5- and 7-MHz operation. Those interested in operation on 7 and 14 MHz may scale the array to one half the dimensions shown.

Gene Brizendine, W4ATE

## swr bridge

The circuit in fig. 3 is a composite of two articles which have appeared in *ham radio* ("Integrated SWR Bridge and Power Meter," May 1970; "SWR Bridge," October 1971).

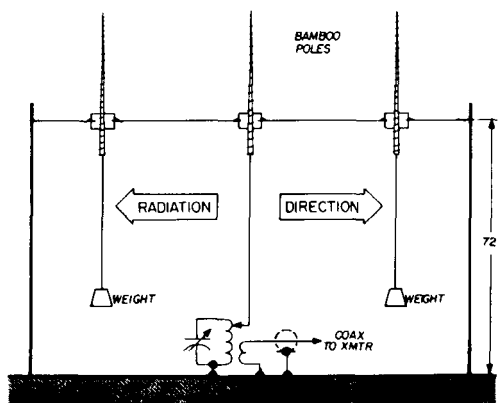

fig. 1. Overview of the "bamboo curtain." The driven element is 68.9', the directors are 65.6' and the elements are spaced 131.2' apart.

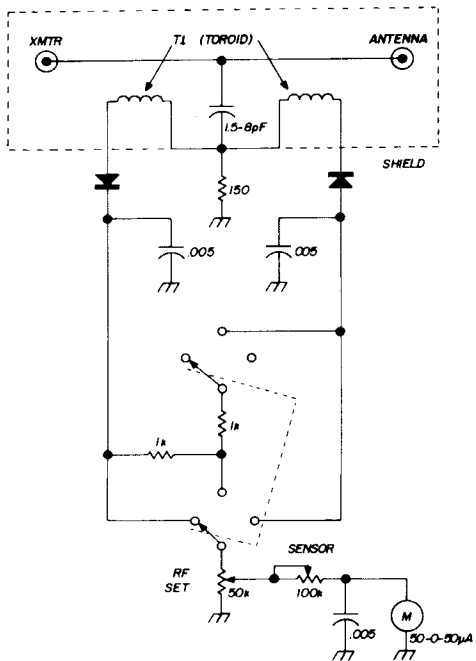

fig. 3. WA5TFK's swr bridge uses a toroid pickup.

I find it rather astonishing that W6DOB's toroid pickup has not received more attention. It takes up very little room, is easy to adjust for a null and is much simpler to construct than the "Monimatch" pickup line.

Output from the toroid at 14 MHz and above was too high for the 100k sensitivity control to handle full scale deflec-

tion of the 50- $\mu$ A meter movement, so a 50k potentiometer was used to make corrections on different bands.

The entire circuit can be constructed in a minibox, size limited only by the size of the components.

Jim Willis, WA5TFK

### soldering aluminum

I am surprised to find many amateurs who still do not know how to solder aluminum with ordinary soldering arrangements. This method is certainly not of my own origin, and I pass it on for those who still might be in the dark.

The procedure requires a good, clean, hot soldering iron, a small amount of light machine oil, a pocket knife and some rosin-core solder. Aluminum takes heat like copper, so a big enough iron is essential. *Do not use a soldering gun.*

Place the oil on the aluminum and gently scrape the oil-covered area with the knife until you are sure that the surface is completely cleaned. *Do not remove the oil.* Make sure the soldering iron is clean and well tinned. Rub the cleaned surface of the aluminum with the flat face of the soldering iron while applying pressure. Feed solder to the tip of the iron and the cleaned aluminum will tin just like copper. Once the tinning is complete, other metals or wires which have been tinned can be joined in the usual manner.

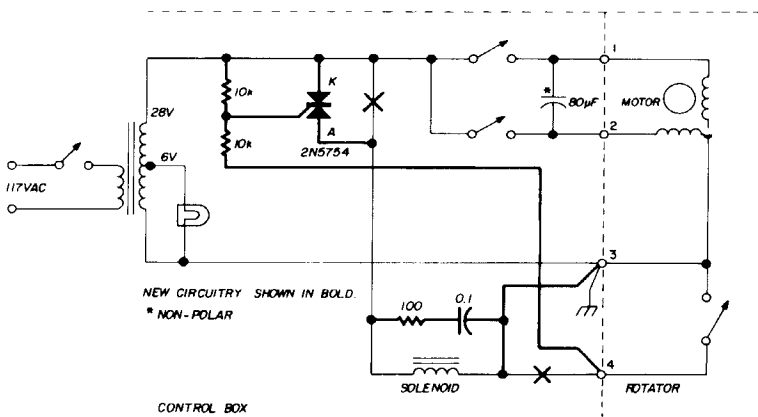

fig. 4. Rotator wiring changes are shown with the heavier lines.

# 2 METER FM

## NEW! HANDY-TALKY

### STANDARD SRC-146



- 5 Channels — .94/.94 and .34/.94 supplied
- .3  $\mu$ V Receiver
- 1.5 W Transmitter
- Compact — 8x3x1 $\frac{1}{2}$ "

Full line of optional accessories includes external speaker-mike, desktop charger, "stubby" antenna — and more

Available NOW

... Only \$279.00

Send QSL or circle number for detailed brochure

**E** **ERICKSON COMMUNICATIONS**  
4659 North Ravenswood Avenue  
Chicago, Ill. 60640 (312) 334-3200

Many thousands of you have become very familiar with the various Radio Society of Great Britain books and handbooks, but very few of you are familiar with their excellent magazine, **Radio Communication**.

It includes numerous technical and construction articles in addition to a complete rundown on the month's events in amateur radio. Surely a most interesting addition to your amateur radio activities.

We can now offer this fine magazine to you along with the other advantages of membership in the RSGB (such as use of their outgoing QSL Bureau) for \$9.95 a year.

**comtec**

Greenville, New Hampshire 03048

When you first try this technique, do not try either too large surface area or too thick a sheet of aluminum because the iron won't be able to supply enough heat to melt the solder. To prove that the metal is hot enough, place a small piece of solder on the aluminum surface near the tip of the iron but not actually touching the iron. The aluminum must get hot enough to melt the solder for the procedure to be successful. This, of course, applies to all soldering techniques because soldering is only successful when the temperature of both metals to be joined is hot enough to melt solder.

Connections soldered to aluminum, incidentally, are vulnerable to attack by moisture which can eventually destroy the joint. Especially important on antennas, the joint should be coated or painted. Just use common sense.

Antenna joints more than five years old are still perfect after being teated with bees wax and PVC tape to keep the moisture out.

Harry L. Booth, ZE6JP

## rotator improvement

My Alliance model HIR2 rotator (vintage unknown but at least 13 years old) generated such interference on the hf bands that beaming in on a signal of unknown direction was very difficult. The actuation of the solenoid every ten degrees of rotation produced broadband energy which drove the receiver agc quite hard so that attempts to rotate for maximum signal strength were defeated. The problem was cured by adding the simple circuitry shown thus reducing the current in the leads up to the rotator.

The R-C circuit across the solenoid damps transients and protects the triac. The triac conducts the current required to operate the solenoid, confining it to the control box, and only the triac gate current need flow in the leads (3 and 4) to the rotator. Of course, the rotator motor is still supplied via leads 1, 2 and 3, but this steady ac produces no interference.

Les Hamilton, K6JVE/3



Complete packaged Multi-Band Antenna Systems employing the famous Bassett Sealed Resonators and a special Balun. Air has been evacuated from both and replaced with pure helium at one atmosphere.

Highly efficient system packages including all hardware, insulation, coax cable, and copperweld elements assembled at the factory. Complete installation instructions included.

Multi-frequency models available for all amateur bands and for commercial use, point to point, ground to air, military and government.

**MODEL DGA-4075 — \$59.50**

A complete system package for primary use in the 40 and 75 meter bands at power levels up to 4KW-PEP with secondary operation in other bands at reduced power levels.

**MODEL DGA-152040 — \$79.50**

A complete system package for primary use in the 15, 20, and 40 meter bands at power levels up to 4KW-PEP with secondary operation in other bands at reduced power levels.

**MODEL DGA-2040 — \$59.50**

A complete system package for primary use in the 20 and 40 meter bands at power levels up to 4KW-PEP with secondary operation in other bands at reduced power levels.

**MODEL DGA-204075 — \$79.50**

A complete system package for primary use in the 20, 40, and 75 meter bands at power levels up to 4KW-PEP with secondary operation in other bands at reduced power levels.

CONTACT YOUR DISTRIBUTOR OR WRITE FOR DATA

**Savoy Electronics, Inc.**

**P.O. Box 7127 - Fort Lauderdale, Florida - 33304**

**Tel: 305-566-8416 or 305-947-1191**

# new products

## no-holes antenna mount



Developed by a ham for his own use, the mobile antenna gutter mount offered by Rejsa Engineering offers a "no holes" method of mobile antenna installation for the hf amateur. The antenna mount is made of very rigid metal and comes complete with all necessary hardware and clear instructions. You can use the mount with a small spring and resonator (not supplied) if desired.

The mount seems to be well engineered and is advertised for amateur, CB, business and police applications. It appears that it would be adaptable to vhf applications also.

The unit is available for \$7.95. Information is available by using *check-off* on page 126 or by writing to Rejsa Engineering Company, 7632 Plymouth Avenue North, Minneapolis, Minnesota 55427.

## transistor manual

Anyone who works with transistors is familiar with the difficulties involved in locating electrical and physical data for a specific type. Unless the manufacturer is known and his published information is available, a long and possibly fruitless search can result. "Transistor Specifications Manual" has been compiled in order to alleviate these problems. It lists the electrical and physical parameters, along with the manufacturers of nearly *ten thousand* transistor types.

For each bipolar transistor in this manual there is given the polarity (nnp or pnp), maximum applied voltages, power dissipation, collector current, operating frequency, collector cutoff current and d-c current gain. A new, separate listing of rf-power transistors includes design frequency, power output, power gain, and collector efficiency in addition to most of the other information. All EIA-registered TO outlines are shown. Where a nonstandard case is used, a dimensioned drawing is provided in a separate section. Transistors are keyed to diagrams that indicate the physical position of the emitter, collector and base terminals. If there is an internal connection to the case, this is noted.

A large quantity of information has been condensed into this "Transistor Specifications Manual" so you can quickly find what you need to know about nearly any transistor.

The new, fifth edition of this handy book is 160 pages long, softbound, and is available from Comtec Books, Greenville, New Hampshire 03048 for \$4.50.



## antenna matcher



The KW107 *Supermatch* is a single package containing a dummy load, antenna switch, swr meter, power meter and the *KW E-Zee Match* antenna tuner. Modern day transceivers must be operated into low-swr terminations for maximum efficiency and long tube and component life. The *Supermatch* was designed to provide a professional uncluttered wife-approved solution to the problem.

The antenna tuner is designed to operate on all bands 80 through 10 meters. It can handle transmitters with power inputs of 1-kW PEP when the natural swr on the transmission line is less than 2:1. For high-impedance feeds the power capability is 350W PEP. The unit works with coaxial and balanced feedlines.

The power dissipation of the air cooled 52-ohm dummy load is a function of time, and is limited by the maximum allowable skin temperature of the glass tin oxide resistor. A graph of time vs average power is included in the instruction book, and ranges from 15 seconds at 2 kW PEP input to continuous service at 90W PEP input.

The wattmeter has two ranges (0-100W and 0-1000W) and measures average power. It is factory calibrated to an accuracy of 5% of full scale. The swr meter in the *Supermatch* is particularly useful because of its high sensitivity. Full scale calibration can usually be achieved with as little as 12W on 80 meters.

The ceramic switch wafers are operated well within their ratings when the other limitations are observed. The

KW107 can be arranged for many switching configurations between a dummy load, two 10-, 15- and 20-meter antennas, two 40- and 80-meter antennas and the built-in antenna tuner.

The KW107 *Supermatch* is priced at \$134.95 from KW Electronics, 10 Peru Street, Plattsburg, New York 12901. In Canada—KW Electronics, 222 Newkirk Road, Richmond Hill, Ontario. More information is available from these addresses or from *check-off* on page 126.

## vhf/uhf mobile antennas



Gain antennas, formerly sold only in the commercial two-way field, are now available for both the 2-meter and 432-MHz amateur bands from Larsen Electronics. The 144-MHz models exhibit 3 dB gain over a quarter-wave whip. The uhf Larsen antennas show 5 dB gain over the same standard.

All Larsen antennas feature silver plated stainless steel whips for maximum efficiency. Bases and loading coils are made from hi-impact epoxy with low silhouette design for minimum wind drag. All will handle a full 100W continuous and when installed with sufficient ground plane will have an swr of 1.3 to 1 or less.

The antennas require no coil tuning or special mounting adapters. Complete cutting charts and mounting hardware are supplied. All antennas are fully guaranteed.

The complete 2 meter Larsen Antenna is designated the NLA-150-K. The uhf model is the NLA-440-K. Each comes with all installation materials including coax, plug, snap-in mount and the complete antenna. The price for either is \$29. The antennas are also available without coax, mounting hardware and fittings at \$24.50. Models can also be obtained to fit all popular types of mount where you supply the mounting hardware.

Complete details are available from Larsen Dealers, by writing directly to Larsen Electronics, P. O. Box 1686, Vancouver, Washington 98663, or by using *check-off* on page 126.

## electric winches



Tri-Ex Tower Corporation has introduced two new electric winches for crank-up towers. The TDD-100 Winch is driven by the average 3/8-inch drill. Two drive bits are furnished with the winch to be inserted into the gear train for raising and lowering. If the drill is not reversible, the short drive bit can be inserted in the opposite end of the winch to lower the load. Braking is automatic and the TDD-100, stopped at any point, will hold a load indefinitely.

The 12 volt electric reversible winch is sold with power cables and an optional battery in weather-tight case and 117 Vac battery charger. It has forward and reverse speeds for raising and lowering the tower, and a level-wind assembly to keep the cable from stacking. Braking is immediate, without coasting or creeping. The electric winch adds a safety feature in eliminating spinning handles, slipping clutches or exposed gears.

Both winches are easily installed and bolt directly onto the existing tower winch mounting frame. Gear train and bearings are packed in lubricant and sealed for life, requiring no additional grease or maintenance.

For complete information on the new electric winches, write Tri-Ex Tower Corporation, 7182 Rasmussen Avenue, Visalia, California 93277, or use *check-off* on page 126.

## transistor tester



Coletronics has introduced an adapter to convert any vom to a transistor and diode tester for out-of-circuit devices. The adapter tests both high-and low-power npn and pnp transistors for shorts, leakage, open circuits and current gain. Diodes can be tested for opens, shorts, and both forward and reverse current without transferring test leads.

The unit comes with instructions and two batteries. It sells for \$14.95 plus \$1 shipping. More information is available from the manufacturer, Coletronics Service Inc., 1744 Rockaway Avenue, Hewlett, New York 11557 or use *check-off* on page 126.

## regency crystal board

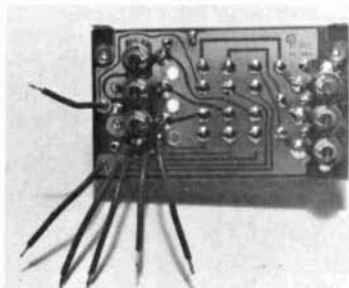

Topeka FM Engineering is selling a new, printed-circuit crystal deck for add-

STRUCTURAL GLASS  
**GEM-QUAD** \*  
FOR 10, 15 AND 20 METERS

# Bridges the Gap

Between Two Worlds

A two element fibre glass quad antenna designed for better signal discrimination & directivity on 10, 15 & 20 meters!

## NEW

- Stronger Arms (closer wound).
- Strong alloy RF wire.
- Improved quality nylon straps.
- UV resistant.
- Low wind resistance (2.4 sq. ft.)

1. Non-corrosive fibreglass construction.
2. Double "Cone-shaped" design maintains critical measurements under severe weather conditions.
3. Lightweight (complete antenna weighs approximately 22 lbs.)
4. Simple T.V. Rotator will rotate antenna.
5. Maximum front to back ratio and side discrimination.
6. Maximum capture area.
7. Low angle radiation.
8. Forward gain for 2 element quad 8db.
9. Optional 3rd element easily installed with no conversion required. Forward gain up to 8.9 db on DX.
10. Single 52 ohm feed line to all bands.
11. No switches or coils required.
12. Low SWR easily obtained.
13. Arm mounts designed for exact element spacing and optimum performance.
14. Nylon tension wire holders eliminates wire strain and breakage.
15. Designed to withstand high winds.

Send for literature

# STRUCTURAL GLASS LIMITED

20 BURNETT AVENUE  
WINNIPEG 16, MANITOBA



\* PATENTED

**\$107**      **\$60**

Two Element Quad      Extra Element Quad

Includes U.S. Customs  
Import Duty or Canadian  
Federal Sales Tax  
Shipped Collect

Please include check or  
money order with your order

**WORLD-WIDE DEALER  
INQUIRIES INVITED**

except U.S., Canada & Mexico

ing six more transmitter frequencies to the Regency HR-2, HR-2A and the Transcan. The 2½ x 1½-inch board has plug-in crystal sockets, fixed NPO capacitors, Teflon wiring and high-quality ceramic trimming capacitors. It comes with all necessary mounting hardware and mounting instructions. The boards are available in kit form for \$9.50 and wired for \$13.50. Shipping for either board is 60c.

More information is available by using *check-off* on page 126 or by writing to Topeka FM Engineering, 1313 East 18th Terrace, Topeka, Kansas 66607.

## antenna coupler



Designed to complement the popular 100- to 200-watt ssb transceiver, a new antenna coupler by RF Communications can match the nominal transceiver 50-ohm output to a resonant doublet or any wire at least 15 feet long. The RF-675 coupler covers the frequency range of 2 to 30 MHz and guarantees a vswr — as seen by the transceiver — of 1.2:1 or less. The unit, which can handle 100-watts average power or 200-watts PEP, has a built-in dummy load for off-the-air tune-up and digital turns counting for rapid resetting of the tuning controls. There is also metering of output, forward and reflected power.

For more information write to RF Communications, Inc., 1680 University Avenue, Rochester, New York 14610 or use *check-off* on page 126.

## antenna accessories

Apollo Products offers a vary complete line of medium-power amplifiers, wattmeters, antenna switches and cabinets. Included in this line is the model 700X rf wattmeter and dummy load covering 80 through 2 meters and featuring power ranges to 10, 300 and 1000 watts along with modulation percentage on transmitters with less than 100 watts output.

The unit offers meter accuracy of 5% below 60 MHz and 8% above 60 MHz. It is completely portable and very ruggedly built. The unit, a passive instrument, comes with a built-in handle, lending itself to portable and field usage. For use, simply connect the transmitter and antenna into two standard SO-239 chassis connectors.

The unit sells for \$124.50. More information is available from Apollo Products, Box 245, Vaughnsville, Ohio 45893 or by using *check-off* on page 126. The Apollo Products catalog includes the complete line of equipment. Apollo also produces a series of deluxe cabinets for home construction. A flyer describing them is available on request from the same address.

## transistor design book

In the second edition of *Practical Design with Transistors*, Mannie Horowitz provides the kind of information that will allow a serious experimenter, engineer or technician to design a transistor circuit from scratch. Much of the cut-and-try work is eliminated by use of the manufacturers specification sheets and appropriate formulas.

Mr. Horowitz provides practical design data and equations but does not devote many pages to equation derivations or the solid-state physics behind transistor operation. The book is overtly a guide to efficient, practical circuit design—not an engineering or physics textbook. The publisher claims that anyone with a working knowledge of algebra and radio elec-

CW or RTTY, whichever way you go,  
**HAL HAS TOP QUALITY  
 YOU CAN AFFORD!**



**TOP QUALITY RTTY... WITH THE HAL MAINLINE ST-6 TU.** Only 7 HAL circuit boards (drilled G10 glass) for all features, plug-in IC sockets, and custom Thordarson transformer for both supplies, 115/230 V, 50-60 Hz. Kit without cabinet, only \$135.00; screened, punched cabinet with pre-drilled connector rails, \$35.00; boards and complete manual, \$19.50; wired and tested units, only \$280.00 (with AK-1, \$320.00).\*



**TOP QUALITY... WITH THE HAL 1550 ELECTRONIC KEYSER.** Designed for easy operation; perfectly timed CW with optional automatic ID for sending call letters, great for DX and RTTY; TTL circuitry, transistor switching for grid block, cathode keying. Handsome rugged crackle cabinet with brushed aluminum panel. With ID, only \$90.00; without ID, \$65.00.\*

**OTHER HAL PRODUCTS INCLUDE:**

ID-1 Repeater Identifier (wired circuit board) . . .	\$ 75.00*
ID-1 (completely assembled in 1½" rack cabinet) . . . . .	\$115.00*
HAL ARRL FM Transmitter Kit . . . . .	\$ 50.00*
W3FFG SSTV Converter Kit . . . . .	\$ 55.00*
Mainline ST-5 TU Kit . . . . .	\$ 50.00*
Mainline AK-1 AFSK Kit . . . . .	\$ 27.50*
HAL RT-1 TU/AFSK Kit . . . . .	\$ 51.50*



**TOP QUALITY... WITH THE HAL MKB-1 MORSE KEYBOARD.**

As easy as typing a letter—you get automatic CW with variable speed and weight, internal audio oscillator with volume and tone controls, internal speaker, and audio output jack. Smooth operation; completely solid-state, TTL circuitry using G10 glass boards, regulated power supplies, and high voltage transistor switch. Optional automatic ID available. Assembled MKB-1, \$275.00; in kit form, \$175.00.\*



**NEW FROM HAL—TOP QUALITY RVD-1002 RTTY VIDEO DISPLAY UNIT.** Revolutionary approach to amateur RTTY . . . provides visual display of received RTTY signal from any TU, at four speeds (60, 66, 75, and 100 WPM), using a TV receiver modified for video monitoring. Panasonic solid-state TV receiver/monitor, or monitor only, available. Complete, \$495.00; Panasonic TV receiver/monitor, \$160.00; monitor only, \$140.00.\*

**TOP QUALITY... WITH THE HAL RKB-1 TTY KEYBOARD.** Gives you typewriter-easy operation with automatic letter/number shift at four speeds (60, 66, 75, and 100 WPM). Use with RVD-1002 video display system, or insert in loop of any teleprinter, for fast and easy RTTY. Completely solid state, TTL circuitry using G10 glass boards, regulated power supplies, and transistor loop switch. Optional automatic ID available. RKB-1 assembled, only \$275.00; in kit form, only \$175.00.\*

HAL provides a complete line of components, semi-conductors, and IC's to fill practically any construction need. Send 24¢ to cover postage for catalog with info and photos on all HAL products available.

\*Above prices do not include shipping costs. Please add 75¢ on parts orders, \$2.00 on larger kits. Shipping via UPS whenever possible; therefore, street address required.

**HAL COMMUNICATIONS CORP.,** Box 365 H, Urbana, Illinois 618

tronics should have no difficulty in designing a transistor circuit with this book.

In order to give the reader a better understanding of design procedure, the characteristics and problems of each particular type of component or circuit configuration are discussed. This is followed by a description of the equivalent circuits and the mathematical relationships of the various parameters. Examples are presented throughout the text to demonstrate the practical use of the final circuit equation as it is applied to determine specific circuit components.

Special consideration has been given to bias stabilization, frequency response, coupling, phase inversion and feedback. Amplifiers, multivibrators and voltage regulators are covered thoroughly as are the characteristics and design applications of silicon controlled rectifiers, uni-junction transistors and fets.

The book is filled with clear schematics, diagrams and curves to provide a valuable information source on transistor circuits for the serious experimenter or engineer. This Howard W. Sams book is 288 pages, softbound and costs \$6.95. It is available from Comtec Books, Greenville, New Hampshire 03048.

## fm transceiver



Linear Systems has introduced a new two-meter fm transceiver, the SBE model SB-144, to complement the new SBE-36 high-frequency ssb transceiver.

The new fm transceiver features 10 watts output, 12 channel capability and a built-in S-meter/rf output indicator. The unit comes with a dynamic microphone

and crystals for the three most popular repeater frequency combinations presently in nationwide use.

More information is available from Linear Systems, Inc., 220 Airport Boulevard, Watsonville, California 95076 or by using *check-off* on page 126.

## 10-MHz oscilloscope



Heathkit is marketing the IO-103, a new 5-inch oscilloscope kit with triggered sweep and response from dc to 10 MHz. The scope features a 6 x 10-cm screen, less than 50-ns vertical rise time for a 50-ns/cm sweep rate, triggered sweep with selection of either normal or automatic modes, switch controlled ac-dc coupling, provision for external triggering signals and horizontal deflection signal, dual 120/240 Vac power supply and front panel connectors for vertical inputs and 1V peak-to-peak signal for checking calibration. The unit costs \$229.95.

Full details on the oscilloscope are available in the latest Heathkit catalog which is available free by using *check-off* on page 126 or writing to Heath Company, Department 122-2, Benton Harbor, Michigan 49022.

## automotive electronics

The active experimenter frequently finds himself working with automotive electronics—installing mobile rigs, theft alarms, modern ignition systems and electronic accessories, along with servic-

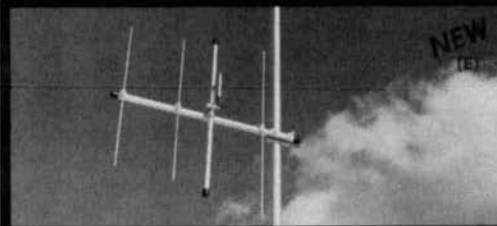
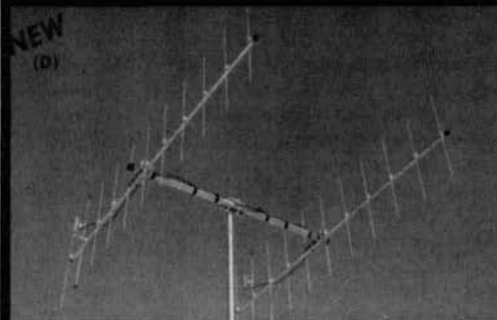
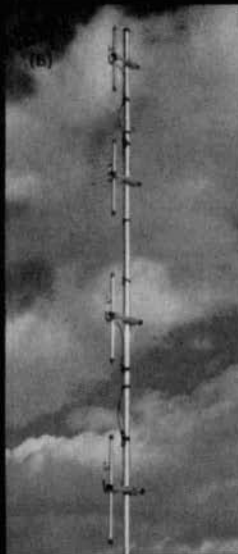
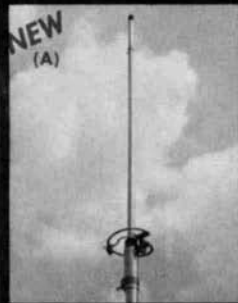

# Cush Craft

## 2 METER FM ANTENNAS

**NEW**

FROM THE WORLD'S LEADING MANUFACTURER OF VHF/UHF COMMUNICATION ANTENNAS

(A) FM RINGO 3.75 db GAIN: The most popular — high performance, half-wave FM antenna. Gives peak gain, and efficiency, instant assembly and installation.

AR-2	100 watts	135-175 MHz	\$12.50
AR-25	500 watts	135-175 MHz	17.50
AR-6	100 watts	50-54 MHz	18.50

(B) 4 POLE: A four dipole array with mounting booms and coax harness 52 ohm feed up to 9 db gain.

AFM-4D	1000 watts	146-148 MHz	\$42.50
AFM-24D	1000 watts	220-225 MHz	40.50
AFM-44D	1000 watts	435-450 MHz	38.50

(C) FM MOBILE 3 db GAIN: Fiberglass 1/2 wave professional mobile antenna for roof or trunk mount. Superior strength, power handling and performance.

AM-147	146-175 MHz mobile	\$26.95
--------	--------------------	---------

(D) 11 ELEMENT YAGIS 13.2 db GAIN: The standard of comparison in VHF communications, now cut for 2 meter FM and vertical polarization.

A147-11	1000 watts	146-148 MHz	\$17.95
A449-11	1000 watts	440-450 MHz	13.95

(D) POWER PACK 16 db GAIN: A 22 element, high performance, vertically polarized FM array, complete with all hardware, mounting boom, harness and 2 antennas.

A147-22	1000 watts	146-148 MHz	\$49.50
---------	------------	-------------	---------

(E) 4 ELEMENT YAGI 9 db GAIN: A special side mount 4 element FM yagi can be fixed or rotated—good gain and directivity.

A144-4	1000 watts	146-148 MHz	\$ 9.95
--------	------------	-------------	---------

(F) FM TWIST 12.4 db GAIN: A Cush Craft exclusive — it's two antennas in one. Horizontal elements cut at 144.5 MHz, vertical elements cut at 147 MHz, two feed lines.

A147-20T	1000 watts	145 & 147 MHz	\$39.50
----------	------------	---------------	---------

IN STOCK WITH YOUR LOCAL DISTRIBUTOR

Cush Craft CORPORATION

621 HAYWARD STREET  
MANCHESTER, N.H. 03103

ing the increasingly complex family car. Far from the simplicity of the Model T, today's car features continually evolving starting, charging, ignition, lighting and indicating systems. Also, more and more electronic test equipment is coming out for car repair—CRT engine analyzers, dwell meters, tachometers and timing gear.

"Automotive Electronics" by Rudolf Graf and George Whalen is 320 pages of text and illustrations exploring the electronics in the modern automobile. Although not directly intended for the radio amateur or experimenter, it is a fascinating book in its own right and also can serve as a handbook of the components, circuitry and test gear common to the ham shack and the garage.

The new book, published by Howard Sams, is softbound, 320 pages and costs \$6.95 from Comtec Books, Greenville, New Hampshire 03048.

## pushbutton transceiver



The new Sonar model FM 3601 10-watt fm transceiver features pushbutton selection of its eight channels. The rig is all solid-state and includes netting trimmers for all receive and transmit crystals on the military-grade, glass-epoxy printed-circuit board. Serviceability, compactness and receiver overload protection are built in.

The unit sells for \$299.95, including a microphone and crystals for 146.94 MHz simplex and 146.34/146.94 MHz repeater use. A descriptive brochure including all the impressive specifications of this new transceiver is available by using *check-off* on page 126 or by writing to Sonar Radio Corporation, 73 Wortman Avenue, Brooklyn, New York 11207.

## hand-held transceiver



Sonar has introduced a five-channel two-meter hand-held transceiver with a minimum 1.6W output. Weighing only 1½ pounds without a snap-in rechargeable battery option, the hand-held unit can run for 8 to 14 hours on a battery charge. Standby current drain is only 10 mA. The unit also boasts FCC type acceptance for use in non-amateur services. Circuitry includes ceramic and crystal band-pass filters and transmitter protection against antenna mismatch. The unit uses all electronic switching (no relays) and military grade components and pc boards throughout. There are connections for optional external antenna, earphone and battery charger. A wide range of accessories and power supplies are offered.

The basic unit sells for \$450.00 with collapsible antenna and shoulder strap, less crystals and nicad battery cartridge. The rechargeable nicad pack is \$30.

The complete specifications on this flexible unit complete with a list of options is available by using *check-off* on page 126 or by writing to Sonar Radio Corporation, 73 Wortman Avenue, Brooklyn, New York 11207.



# Semiconductor Supermart

• MOTOROLA • RCA • FAIRCHILD • NATIONAL • HEP • PLESSEY •



Actual Size

## DIGITAL READOUT

At a price everyone can afford **\$3.40**

- Operates from 5 VDC
- Same as TTL and DTL
- Will last 250,000 hours.

The MINITRON readout is a miniature direct viewed incandescent filament (7-Segment) display in a 16-pin DIP with a hermetically sealed front lens. Size, and appearance are very similar to LED readouts. The big difference is in the price. Any color filter can be used.

## SPECIAL OFFER

- Digital readout
- BCD to 7 — Segment Decoder/driver
- 7490 Decade Counter
- 7475 Latch

Only **\$8.40**

## PLESSEY SL403D

**3.5 W AUDIO AMP IC**  
**HI-FI QUALITY**

**\$3.95**

with 12 pages of construction data

## NATIONAL DEVICES

LM370 AGC/Squelch amp	\$4.85
LM373 AM/FM/SSB IF strip/Det	\$4.85
LM309K 5V 1A regulator. If you are using TTL you need this one.	\$3.50

## POPULAR IC's

MC1550	Motorola RF amp	\$1.80
CA3020	RCA 1/2 W audio	\$3.07
CA3020A	RCA 1 audio	\$3.92
CA3028A	RCA RF amp	\$1.77
CA3001	RCA	\$6.66
MC1306P	Motorola 1/2 W audio	\$1.10
MC1350P	High gain RF amp/IF amp	\$1.15
MC1357P	FM IF amp Quadrature det	\$2.25
MC1496	Hard to find Bal. Mod.	\$3.25
MFC9020	Motorola 2-Watt audio	\$2.50
MFC4010	Multi-purpose wide-band amp	\$1.25
MFC8040	Low noise preamp	\$1.50
MC1303P	Dual Stereo preamp	\$2.75
MC1304P	FM multiplexer stereo demod	\$4.95

## FETs

MPF102	JFET	\$6.60
MPF105/2N5459	JFET	.96
MPF107/2N5486	JFET VHF/UHF	\$1.26
MPF121	Low-cost dual gate VHF RF	.85
MFE3007	Dual-gate	\$1.98
40673		\$1.75
3N140	Dual-gate	\$1.95
3N141	Dual-gate	\$1.86

## PLESSEY INTEGRATED CIRCUITS GREAT FOR SSB RCVRs AND XMTRS

SL610	low noise 150 MHz RF good AGC	\$5.65
SL612	low distortion IF good AGC	\$5.65
SL621	AGC generator for SSB rcvrs	\$8.30
SL620	AGC gen. SL630 Audio	\$8.30
SL630	multipurpose audio amp	\$5.35
SL640	top performing balanced mixer	\$10.88
SL641	low-noise rcvr mixer	\$10.88

## SIGNETICS PHASE LOCKED LOOP

NE561B	Phase Lock Loop	\$9.50
NE562B	Phase Lock Loop	\$9.50
NE566V	Function Generator	\$9.50
NE567V	Tone Decoder	\$9.50
N5111A	FM/IF Demodulator	\$2.65

## PREMIUM QUALITY TEXAS INSTRUMENTS TTL IC's

7447	7-seg. decoder/driver for the digital readout.	\$2.25
7400	gates	.35
7441	NIXIE driver	\$1.95
7490	decade counter	\$1.40
7475	quad latch	\$1.40
7495	shift Reg.	\$2.00
7493	divide by 16	\$1.90
74121	monostable	\$1.80
7473	dual flip-flop	.85

## MOTOROLA DIGITAL

MC724	Quad 2-input RTL Gate	\$1.00
MC788P	Dual Buffer RTL	\$1.00
MC789P	Hex Inverter RTL	\$1.00
MC790P	Dual J-K Flip-flop	\$2.00
MC799P	Dual Buffer RTL	\$1.00
MC1013P	85 MHz Flip-flop MECL	\$3.25
MC1027P	120 MHz Flip-flop MECL	\$4.50
MC1023	MECL Clock driver	\$2.50
MC4024	Dual VCO	\$3.00
MC4044	Freq. Phase Det	\$3.00

## TRANSISTORS & DIODES

MPS6571		.60
MPS A12	NPN Darlington gain 20K	.90
2N706	packet of 4	\$1.00
2N2218	packet of 2	\$1.00
1N4001	packet of 6	\$1.00
1N4002	packet of 6	\$1.00
1N4004	packet of 6	\$1.00

Please add 35¢ for shipping

## CIRCUIT SPECIALISTS CO.

Box 3047, Scottsdale, AZ 85257

FACTORY AUTHORIZED  
HEP-CIRCUIT-STIK  
DISTRIBUTOR

## tone decoder

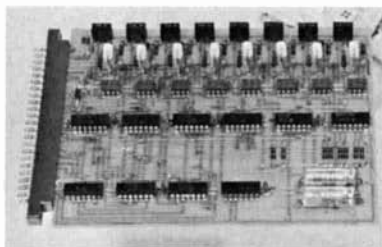

A flexible new tone decoder is available from Lee-Com Associates of Cleveland, Ohio. While lending itself primarily to vhf repeater control, the unit is also suitable for data communications terminals, traffic control, station control and security systems.

The Multitone decoder can decode 12 functions (3-by-4 pad) with high-true TTL outputs in decimal form and high-true outputs in 4-line BCD (0-9). It can decode 7 tones from a standard pad with 100 mA low-true sink drive for bulbs and relays. It has separate high and low groups HIT out for single tone detection and two-tone PARITY output for simultaneous tone detection.

The unit operates from a 5-Vdc power supply and is built on a military grade glass-epoxy pc board. The board measures 4½ x 6½ inches. Options include light-emitting diode lamps to indicate 7 or 8 demodulated tones, and a version of the decoder to handle 16 functions, 8 tones (4-by-4 pad). The basic decoder sells for \$169.95, the 16 function decoder for \$189.95 and the 8 LED display sells for \$18.00.

Complete information is available from Lee-Com Associates, Box 43204, Cleveland, Ohio 44143 or by using *check-off* on page 126.

## heath digital frequency display

The Heath Company has introduced the SB-650 Digital Frequency Display, a digital computer for use with Heathkit receivers and transceivers that calculates operating frequency and displays it via numerical readout tubes as the amateur

tunes across the band. The unit is usable with all Heathkit SB-series and HW-series multiband transceivers.

Unlike any other counter on the market, the SB-650 actually computes a received or transmitted frequency using the three different frequencies produced by the heterodyne oscillator, LMO and bfo in the receiver/transceiver. Six read-out tubes display the frequency in MHz, kHz and hundreds of Hz with accuracy within 100 Hz  $\pm$  1 count.

Priced at \$179.95 mail order, the Heathkit Digital Frequency Display boasts all solid-state circuitry with 35 ICs and six transistors. The only control is an external on/off switch. Four internal adjustments permit reducing generated spurious frequencies to lower than 0.25  $\mu$ V equivalent signal level.

More information on this new display is available by using *check-off* on page 126 or by writing to the Heath Company, Benton Harbor, Michigan 49022.

## meters

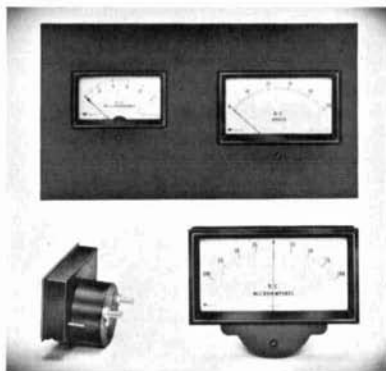

A new designer-styled *GL/B* panel meter series has been introduced by Triplet. Flat and rectangular shaped, the meters feature glass windows with a modern front resembling a bezel. Similar to bezel mounted meters, the new meters mount easily behind the panel but they do not need the normal bezel hardware, thus saving cost and installation time. The new meters take up a minimum of panel space and their raised border can be painted or printed to further enhance a panel.

# MAGNUM SIX

RF SPEECH PROCESSOR FOR  
COLLINS 'S' LINE & HEATH 'SB'/'HW'\* SERIES

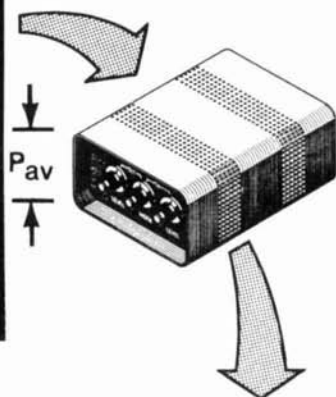
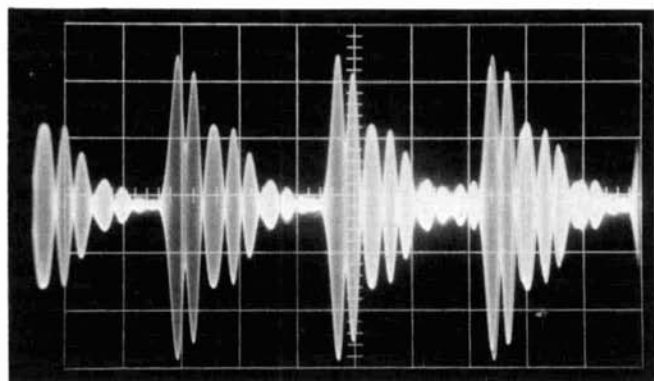

KWM-2 SB100  
32S - 1 SB101  
32S - 3 SB102  
SB400  
SB401  
\*HW100  
\*HW101

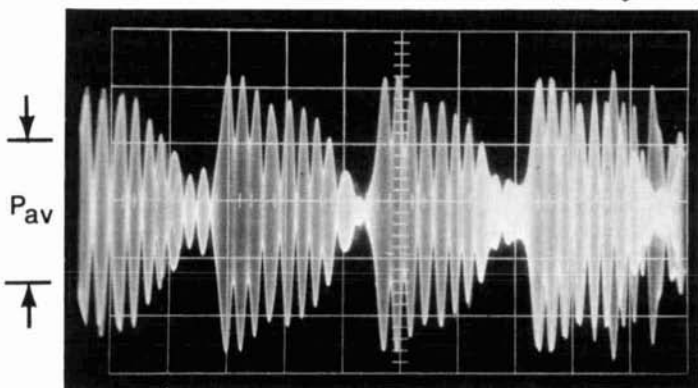

INTRODUCTORY  
OFFER

~ \$129.95 ~

Postpaid U.S.  
(Add 5% in Washington)

- TRUE RF SPEECH CLIPPING
- $\geq 6$ db AVERAGE POWER GAIN
- DUPLICATE O.E.M. CRYSTAL (HEATH) OR MECHANICAL (COLLINS) FILTER
- HIGHEST QUALITY SOLID STATE COMPONENTS
- REGULATED FAIL-SAFE POWER SUPPLY

Send for FREE Brochure  
Communication Technology Group  
(A Division of Bitcil Systems Inc.)  
31218 Pacific Highway South  
Federal Way, Washington 98002



Communication Technology Group  
A Division of Bitcil Systems Inc.

# HAMFEST

WESTERN N. Y.  
HAMFEST and  
VHF CONFERENCE

MAY 13, 1972

Monroe County  
Fairgrounds  
Rt. 15A  
Rochester, N. Y.  
(Near Thruway Exit 46)

- Huge Flea Market
- Top Programs
- Award Presentations
- Banquet
- Friday Night Cocktails

WRITE:  
WNY HAMFEST  
BOX 1388  
ROCHESTER, N. Y.  
14603

## HOW SMALL

## CAN YOU GET?

Would you believe that we put a four pole 10.7 MHz crystal filter in an HC6/U can? Type XM 107SO4: Bandwidth 14 kHz, ultimate attenuation 60 dB min., insertion loss 3 dB max.

Now available from stock for \$15.95.

And don't forget our line of eight pole narrow and wideband FM 10.7 MHz crystal filters (\$30.25) and discriminators (\$14.95). Or the famous XF 9B SSB filter for 9 MHz (\$32.85), the XF 9M and XL 10M CW filters (\$24.49 and \$65.64) and the XF 9D AM filter (\$35.40) . . .

**si**

SPECTRUM  
INTERNATIONAL  
BOX 87 TOPSFIELD  
MASSACHUSETTS 01983

Two-stud mounting is standard on all of the new *GL/B* series panel instruments. Three basic sizes are available, 3½, 4½ and 5½ inches. The case barrel of the new *GL/B* series, housing the meter movement, has been designed so that it extends only 1.840 inch from the panel mounting, saving valuable back-of-the-panel space and permitting quick mounting. Back-of-the-panel supporting brackets are provided with each new Triplet panel instrument in the series.

Both pivot and jewel movements, as well as suspension types, are used in the new panel instruments. They are available in many ranges of dc voltmeters (1000 ohms per volt), dc and ac milliammeters, dc and ac ammeters, dc microammeters, dc millivoltmeters, rf thermoammeters, decibel meters, ac voltmeters (rectifier type) and volume unit meters.

The new *GL/B* series, with the standard two-stud mounting, is available from Triplet Modification Centers and company stocks. For additional data, write to Triplet Corporation, *GL/B* Department, Bluffton, Ohio 45817 or use *check-off* on page 126.

## scanning receiver

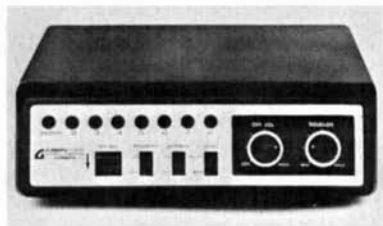

Gladding has introduced a new vhf scanning receiver with a number of unusual features. Off-the-shelf, it covers not just the two-meter amateur band but up to eight crystal-controlled frequencies anywhere from 144 to 175 MHz. The unit also offers a priority channel to which the set will automatically revert regardless of reception on other channels. The HiScan has a built-in 117 Vac and 12 Vdc power supply and a trap door for rapid crystal changing. The unit sells for \$114.95.

More information is available by using *check-off* on page 126 or by writing to Gladding Corporation, Pearce-Simpson Division, Box 800 Biscayne Annex, Miami, Florida 33152.

## digital multimeter



Heathkit is offering a new digital multimeter boasting 0.2% accuracy, a built-in calibrator and 3½ digit readout. A "half-digit" readout tube indicates only the digit one rather than 0-9. It can be used to change a meter with a maximum readout of 999 to one reading 1999.

Features of the new meter include the ability to change polarity measurements without having to change leads or throw a switch. The meter reads ac voltages from 100  $\mu$ V to 500V, dc from 100  $\mu$ V to 1000V, current from 100 nA to 2A and resistance from 0.1 ohms to 20 megohms. Input impedance is 1000 megohms on the 2V range, 10 megohms or higher on the other ranges.

The decimal point is placed automatically and the meter has built-in overload protection and a front-panel over-range indicator.

A dc calibrator is furnished and an internal circuit and unique transfer method allow accurate ac calibration. Solid-state design with cold-cathode readout tubes and memory circuit give stable, non-blinking operation. The kit includes standard banana jack connectors complete with test leads. The kit sells for \$229.95, plus shipping.

More information is available in the latest Heathkit catalog, available by using *check-off* on page 126 or by writing to the Heath Company, Department 122-2, Benton Harbor, Michigan 49022.

# HERE IS THE 72 CALL BOOK

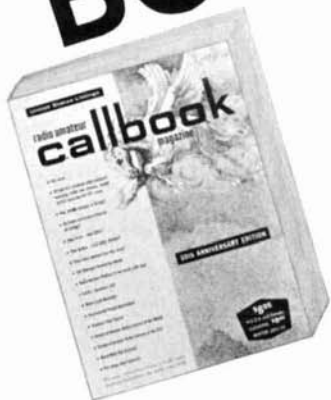

Remember — the Callbook is now publishing only one US Edition and one Foreign Edition each year. Get your 1972 editions now and you'll get maximum use from them.

Supplements are available at modest cost which will keep your investment up to date all year long.

See the Callbook ad on page 49 for full details.

### Send today

US 1972 Callbook	\$8.95
Foreign 1972 Callbook	\$6.95
Add .25 postage and handling	

comtec

BOOKS

Greenville, New Hampshire 03048

# NEW from **RP** TONE BURST ENCODERS

- UP to 5 fixed tones (factory set)
- ADJUSTABLE:  
—Duration  
—Output
- NO BATTERIES needed.
- FULLY ADAPTABLE
- EASY INSTALLATION
- CONTINUOUS TONE POSSIBLE
- FULL 1 YEAR RP Warranty



**PRICES:**  
**TB-5 5 tone std. encoder** ..... \$37.50  
 (1800, 1950, 2100, 2250, 2400 Hz.)  
**ST-2 Single tone decoder** ..... \$37.50  
 (Specify 1800, 1950, 2100, 2250, or 2400 Hz.)

Special tones — Inquire  
 Add \$1.80/unit for shipping (Ill. residents add 5% tax)

FREE SPEC SHEETS  
 NOW AVAILABLE  
 ORDER DIRECT OR FROM  
 AUTHORIZED DEALERS

**RP Electronics**  
 BOX 1201H  
 CHAMPAIGN, ILL.  
 61820

## CRYSTAL BARGAINS

Depend on . . .

We supply crystals from 16 KHz to 100 MHz in many types of holders. Over 6 million crystals in stock. We manufacture crystals for almost all model SCANNERS, MONITORS, 2-WAY RADIO, REPEATERS, ETC. Inquire about special quantity prices. Order direct with check or money order.

For first class mail add 15¢ per crystal...for airmail add 20¢ ea.



DIVISION OF BOB  
 WHAN & SON  
 ELECTRONICS, INC.

2400 Crystal Dr.  
 Fort Myers  
 Florida 33901  
 (813) 936-2397

Send 10¢ for new catalog with oscillator circuits and lists of thousands of frequencies in stock.

### SPECIALS! CRYSTALS FOR:

Frequency Standards	
100 KHz (HC13/U)	\$4.50
1000 KHz (HCG/U)	4.50
Almost All CB Sets, Trans. or Rec. (CB Synthesizer Crystal on request)	2.50
Any Amateur Band in FT-243 (Except 80 meters)	1.50
80 Meter Range in FT-243	4 for 5.00
Color TV 3579.545 KHz (wire leads)	2.50
	1.60
	4 for 5.00

## miniature tone encoder

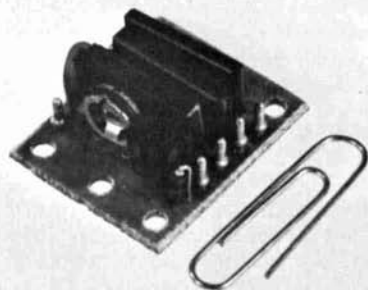

Alpha Electronic Services has introduced a new thick-film hybrid tone encoder model ST-85J, designed for use in portable and hand held communications equipment. This compact, easily-installed unit provides an economical method of controlling repeaters, remote base stations or special functions. When used where CTCSS tone quieting is desired, the ST-85J will provide the necessary sub-audible tone to activate the decoder in the base station. For special control functions, paging, or selective repeater entry, the unit is available in high frequencies as well as sub-audible (20 Hz to 3000 Hz).

The thick-film hybrid technique along with the use of ICs achieves extremely small size and long-term reliability. Frequency stability is  $\pm 0.5\%$  over a temperature range of  $-30^\circ$  to  $+100^\circ$  C and current requirements are less than 4 mA at 12.6V.

The unit comes with a number of different installation kits and step-by-step instructions for easy installation in any make or model radio. The unit sells for \$47.00, postpaid. More information is available by using *check-off* on page 126 or by writing to Alpha Electronic Services, Inc., 8431 Monroe Avenue, Stanton, California 90680.

## plugboards

Vector has introduced a new line of miniaturized plugboards specifically designed for mounting dual in-line packages and discrete components with leads spaced on 0.1-inch increments. All of the plugboards have an overall grid of 0.042-

inch holes on 0.1-inch centers and are 2.7-inches wide by 4.5-inches long in economical phenolic or mil-spec epoxy glass material with a choice of one or two ounce copper etched contacts on 0.156-inch or 0.1-inch centers respectively. Contacts are tinned or nickle-plated and gold-flashed for high reliability applications.

To insure widest possible usage, a variety of etched patterns are offered on the boards. Patterns offered include models with interleaved vertical buses for Vcc and ground and groups of three hole pads for IC mounting, or models with buses only, which are intended for mounting sockets for wire wrapping. For users of hybrid circuitry, models are available without any pattern on the upper portion of the board, and Vector Edge Pin contacts which permit nearly any style hookup.

To complete the package, the firm has a complete line of terminals and sockets to go with the boards as well as card cages and extruded cases for packaging the plugboards.

Prices of the boards range from \$2.19 to \$5.55 and quantity discounts are available. Boards are available now from the firm's authorized industrial distributors. For more information write to Vector Electronics Company, 12460 Gladstone Avenue, Sylmar, California 91342 or use *check-off* on page 126.

## miniature microphones

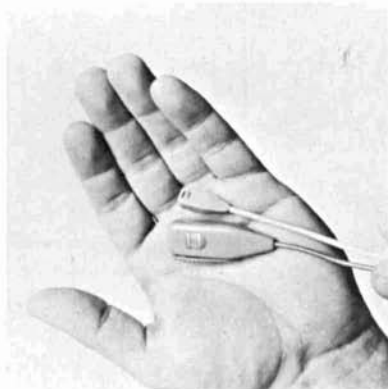

Two styles of miniature push-to-talk microphones for use specifically with 2-way communications equipment are

• LEADERS IN COMPACT ANTENNAS •

## MAXIMUM EFFICIENCY/MINIMUM SIZE

FOR APARTMENTS • SUBURBAN HOMES

Marine and Portable Operation

Packaged for APO and FPO Shipping



ALL MODELS COMPLETELY WEATHERPROOFED

**NEW**

### B-24 + RK-3 COMBINATION

**3 ELEMENTS**  
10-15-20  
METERS

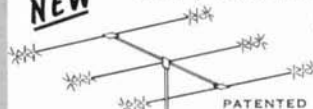

Bands	10-15-20 Meters
Power Rating	1400 Watts P. E. P.
Total Boom Length	11'
Turning Radius	7'-10"
Total Weight	23 lbs.
Single Feed Line	52 ohm
SWR at Resonance	1.5 to 1.0 max.

**B-24 + RK-3 Combination Net \$94.95**  
**RK-3 Reflector Kit (only) Net \$36.95**

The features of the popular B-24 plus the new RK-3 reflector kit make a unique 3 element combination. Choose the combination or add the RK-3 to your present B-24 and enjoy the improved gain and front to back.

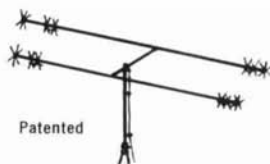

**6-10-15-20 METERS**

The time proven B-24 4-Band antenna combines maximum efficiency and compact design to provide an excellent antenna where space is a factor. New end loading for maximum radiation efficiency. No center loading.

Bands	6-10-15-20 Meters
Power Rating	1400 Watts P. E. P.
El. Length	11'
Turn. Radius	7'
Total Weight	13 lbs.
Single Feed Line	52 ohm
SWR at Resonance	1.5 to 1.0 max.

**Model B-24**  
**Net \$62.95**

### MULTIBAND COAXIAL ANTENNA for 6 - 10 - 15 - 20 METERS

Needs no ground plane radials. Full electrical 1/2 wave on each band. Excellent quality construction. Mount with inexpensive TV hardware. Patented.

Power Rating	1400 Watts P. E. P.
Total Weight	6 lbs.
Height	11'
Single Feed Line	52 ohm
SWR at Resonance	1.5 to 1.0 max.

**Model C4 Net \$36.95**

See our entire line at your nearby distributor or write the factory for further information and literature.



**Mini-Products, Inc.**

Call 814 - 454-2171

1001 W. 18th Street • Erie, Pennsylvania 16502

## KOJO AUDIO FILTERS FOR SSB AND CW

The KOJO audio filters can greatly improve reception on all receivers, even the most sophisticated receivers. Large amounts of high-frequency hiss, background noise and sideband buckshot can be removed.

The SSB filter is of a low pass configuration, designed with a sharp cutoff to provide a rejection of better than 30 decibels at all ham band frequencies above approximately 3500 Hz. The filter is specifically designed to be placed in a low-impedance line for earphones or speaker.

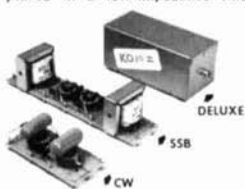

The CW filter has a spot frequency of 780 Hz and a passband of 1100 Hz with a reference level, 40 decibels below the signal level at the design frequency. The peak of the passband is 100 Hz wide at the —3 decibel reference points. The CW filter is specifically designed for low-impedance input and high-impedance output. High-impedance crystal earphones are recommended. However, with low impedance earphones a small auxiliary amplifier or impedance matching transformer may be used.

impedance input and high-impedance output. High-impedance crystal earphones are recommended. However, with low impedance earphones a small auxiliary amplifier or impedance matching transformer may be used.

KOJO filters are made up of top grade coils and components and are available in easy to assemble kit form with simplified instructions, or in a deluxe model. The deluxe model is completely built up and ready for use and is enclosed in a Gray cabinet<sup>®</sup> with convenient IN-OUT switch.

Try a KOJO and see what you can hear now and could not clearly hear before.

<sup>®</sup>Slight cabinet layout changes subject to take place without notice.

**CW Filter Kit \$ 8.95     Deluxe CW Filter \$16.95**  
**SSB Filter Kit \$12.95     Deluxe SSB Filter \$21.95**

All filters shipped postpaid. Arizona residents add 4% sales tax.

## THE J. LYNCH CO.

P. O. Box 7774, Phoenix, Arizona 85011

now being offered by Controlonics Corporation of Littleton Common, Massachusetts.

These new magnetic microphones are designed specifically for use with personal portable or hand-held transceivers. The Mini-Mike is 2-inches long, 5/8-inch wide and 15/32-inch thick and weighs 1/2 ounce with cord. Response is centered on the 300- to 5000-Hz range with a sensitivity of minus 76 dB at 1000 Hz. The dependable magnetic microphone element is self-shielded against magnetic fields and has a nominal impedance of 4000 ohms.

The Micro-Mike is 1-inch long, 0.365-inch wide and 0.285-inch thick and weighs 1/10 ounce. The useful frequency is from 400 to 5000 Hz and sensitivity is minus 80 dB at 1000 Hz.

More information is available from Controlonics Corporation, One Adams Street, Littleton Common, Massachusetts 01460 or by using *check-off* on page 126.

## alignment tools

Jensen Tools offers a new kit of 25 tools for the advanced amateur, experimenter and serious electronic technician. Designated 23C750, the kit includes virtually every alignment tool needed for work on radio-frequency electronic circuits used in amateur, mobile, marine and TV equipment.

Each tool provides the necessary isolation between operator's hand and the equipment tested. Included in the complement of tools are a universal aligner, long-reach core aligner, extra-thin tuning wand, bone fiber tuner, Delrin-tipped i-f transformer aligner, oscillator aligners, and special TV aligners (for Motorola, Stewart-Warner, Belmont, Zenith, RCA and Westinghouse). Working ends include slotted, recessed and hex styles, ranging in tip size from 1/32-inch to 1/4-inch.

The 25 precision tools are furnished in a rugged roll pouch which fits conveniently into tool chest or desk drawer. The pouch is designed for easy removal and replacement of tools, and has a fold-over



## Radio Amateurs Reference Library of Maps and Atlas

**WORLD PREFIX MAP** — Full color, 40" x 28", shows prefixes on each country . . . DX zones, time zones, cities, cross referenced tables . . . postpaid **\$1.25**

**RADIO AMATEURS GREAT CIRCLE CHART OF THE WORLD** — from the center of the United States! Full color, 30" x 25", listing Great Circle bearings in degrees for six major U.S. cities; Boston, Washington, D.C., Miami, Seattle, San Francisco & Los Angeles. . . . postpaid **\$1.25**

**RADIO AMATEURS MAP OF NORTH AMERICA!** Full color, 30" x 25" — includes Central America and the Caribbean to the equator, showing call areas, zone boundaries, prefixes and time zones, FCC frequency chart, plus informative information on each of the 50 United States and other Countries. . . . postpaid **\$1.25**

**WORLD ATLAS** — Only atlas compiled for radio amateurs. Packed with world-wide information — includes 11 maps, in 4 colors with zone boundaries and country prefixes on each map. Also includes a polar projection map of the world plus a map of the Antarctica — a complete set of maps of the world. 20 pages, size 8 3/4" x 12" . . . . . postpaid **\$2.00**

**Complete reference library of maps — set of 4 as listed above . . . . . postpaid **\$3.50****

See your favorite dealer or order direct.

**WRITE FOR FREE BROCHURE!** RADIO AMATEUR **callbook** INC.  
 Dept. E 925 Sherwood Drive  
 Lake Bluff, Ill. 60044



flap which prevents tools from being lost.

The 23C750 alignment set is available for under \$17.00, postpaid. For further information contact Jensen Tools and Alloys, 4117 North 44th Street, Phoenix, Arizona 85018 or use *check-off* on page 126.

## subminiature tool kit

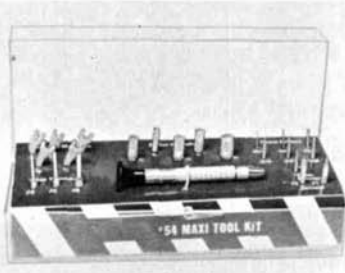

Tiny multi-purpose instrument tools in a 22-piece set are now available for use on very small fasteners. Suitable for use on meters, clocks, models and miniaturized projects, the tools are designed for instrument repair and light assembly work involving very small nuts, set screws and machine screws.

The tool set, Mini Kit Number 54, contains six jewelers' type screwdrivers in sizes 0.025, 0.040, 0.050, 0.070, 0.080 and 0.100 inch, two cross-recessed Phillips-type drivers in sizes 0 and 1, five open-end wrenches in sizes 5/16, 3/32, 7/64, 1/8 and 5/32 inch, three Allen-hex type wrenches in sizes 4, 6 and 8, five socket wrenches sizes 5/64, 3/32, 7/64, 1/8 and 5/32 inch, a marking scribe and a knurled chuck-type handle for positive gripping. The blades are interchangeable, and all are made of hardened, tempered nickel-plated tool steel.

The complete set is packaged in a clear plastic box for easy use and convenient storage. It is priced at \$14.50, postage paid. For further information, contact Jensen Tools and Alloys, 4117 North 44th Street, Phoenix, Arizona 85018 or use *check-off* on page 126.

## DIODES

PIV	TOP-HAT		EPOXY		STUD-
	1.5 AMP	1.5 AMP	3 AMP	3 AMP	MOUNT 6 AMP
50	.04	.06	.12	.15	
100	.06	.08	.16	.20	
200	.08	.10	.20	.25	
400	.12	.14	.28	.50	
600	.14	.16	.32	.58	
800		.20	.40	.65	
1000		.24	.48	.75	

## ZENERS

All Units Tested And Guaranteed

400 MILLIWATT UNITS — 3, 3.3, 3.6, 3.9, 4.3, 4.7, 5.6, 6.2, 6.8, 7.5, 8.2, 9.1, 18, 22, 24, 27, Volts.

1 WATT UNITS — 10, 11, 12, 13, 15, 16, 18, 20, 22, 27, 30, 33, 39, 43, 47, 51, 56, 62, 68, 75, 82, 91, 100, 110, 120, 130, 150, 160, 180, Volts. ALL UNITS 10% — 4 for \$1.00 ppd. 5% — 3 for \$1.00 ppd.

### MOLDED 1½ AMP BRIDGE RECTIFIER

1200 Volts PIV Per Leg. Ideal For P.C. Board Use. Size Approximately 1/2" Square x 3/16" Thick.

\$1.00 each 3 for \$2.50 ppd.

JUST ARRIVED! Fully Shielded 6.3 Volt @ 1½ Amp Transformer. Very Nice.

\$1.50 Each ppd.



3000 MFD @ 30 Volt Capacitors. Size 1" Diameter x 3" Long. 75¢ Each or 3 For \$2.00 ppd.



0-1 ma. — Rectangular. Size: 5/8" x 1 3/8" With 1/4" Depth Behind Panel. Zero Adjust Provided. May Be Adjusted For Zero Center With Instructions Supplied. Very Nice.

\$1.00 Each ppd.

1N4002 Silicon Diodes 12¢ Each ppd.

1N4004 Silicon Diodes 18¢ Each ppd.

1N4007 Silicon Diodes 28¢ Each ppd.

### 113 VOLT TRANSFORMER

32-0-32 Volts At 1 Amp Secondary. Also Low Current 6.3 Volts Secondary For Pilot Lights.

\$2.50 Each ppd.



3 AMP BRIDGE RECTIFIER 400 Volts PIV Per Leg. Manufactured by Semtech.

\$1.00 Each or 3 For \$2.50 ppd.



115 VOLT TRANSFORMER 17-0-17 Volt @ 150 ma. Secondary With Tap At 6.3 Volts For Pilot Light.

\$1.50 Each ppd.

### HIGHEST QUALITY, AMERICAN MADE POWER CORD

6 Foot Gray Cord. Good For At Least 7 Amps. Plugs Into Auto Cigarette Lighter. A Hard To Find Item. 75¢ Each or 3 For \$2.00 ppd.

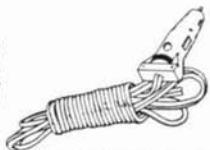

### 1 AMP MOLDED BRIDGE RECTIFIER



200 Volt PIV Small Size — Manufactured By General Instrument. Ideal For P.C. Board.

50¢ Each, 3 For \$1.25 ppd.

SEND STAMP FOR BARGAIN LIST Pa. residents add 6% State sales tax ALL ITEMS PPD. USA

**m. weinschenker**  
K 3DPJ BOX 353 · IRWIN, PA. 15642

## FREQUENCY STANDARD



Only  
**\$32.50**  
(less batteries)  
POSTPAID USA

- Precision crystal
- Fully guaranteed

- Markers at 100, 50, 25, 10 or 5 kHz selected by front panel switch.
- Zero adjust sets to WWV. Exclusive circuit suppresses unwanted markers.
- Compact rugged design. Attractive, completely self contained.
- Send for free brochure.

## PALOMAR ENGINEERS

BOX 455, ESCONDIDO, CA 92025

Join the Gang on  
2 METER FM  
with a **GLADDING 25™**



25 WATTS OUTPUT — .3uv/12db SINAD sensitivity. 6 separately switched receive and transmit ch. 12 volt DC power supply built-in — 117v AC power supply accessory in matching case. Crystal lattice filter — Glass epoxy boards.

unit only **\$249.95\***  
with AC supply **\$299.95\***

For more information, call or write:

**BILL'S RADIO**  
RR1, BOX 41C, SOUTH ROAD  
WADING RIVER, N. Y. 11792  
516-929-6118

\* suggested list prices

## strip printer

The details of the strip printer used in the "Automatic Fist Follower" in the November, 1971 issue of *ham radio* were accidentally deleted. The unit in the lead photograph is the Computer Terminal System's Model 4 strip printer. This little unit prints at 35 characters per second on pressure-sensitive 15/32-inch paper tape. The entire alphabet, digits 0 through 9 and 28 symbols make up the 64 characters which this machine is capable of printing. While other print codes are optional, ASCII is standard. The unit is normally powered by 117 Vac, but optional 220-Vac and 12-Vdc versions are available.

The units feature modular construction and extensive use of ICs. Many options are offered. It measures 4-1/8 x 8-7/8 x 3-inches. The complete mechanical and electronic specifications on this unit and the entire line of CTS strip printers are impressive. They are available from Computer Terminal Systems, Inc., 52 Newton Plaza, Plainview, New York 11803 or by using *check-off* on page 126.

## electronic equipment catalog



An amateur bands receiver, an SWL receiver and a parcel of vhf monitors and

Citizens Band equipment are included in the 1972 Radio Shack Electronic Equipment Catalog. Along with this communications gear, the 92-page full-color catalog includes a wide range of audio and home entertainment equipment, public address systems, tape recording and cassette gear and a selection of intercoms and hi-fi speakers.

The new catalog is available free at any Radio Shack store. Allied Radio Shack, 2617 West Seventh Street, Fort Worth, Texas 76107.

## walkie-talkie encoders

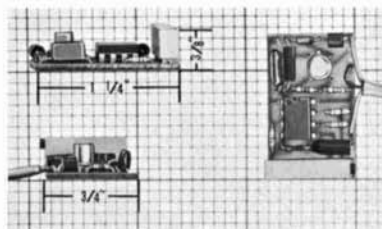

Ross and White have expanded their line of tone encoders for entry into tone access fm repeaters. The most recent encoder is the model TE-P, a single tone, factory-preset tone-burst encoder for installation in hand-held fm transceivers. The unit is field adjustable over the range of 1700 to 2500 Hz. It features all American manufacture, IC design, low current drain and adaptability to almost any portable. The unit is tiny, measuring  $1\frac{1}{4} \times \frac{3}{4} \times \frac{3}{8}$  inches and comes with mounting details for your specific transceiver. Ross and White will be arranging factory installation of the encoders for those who do not want to handle the installation in the limited spaces in most walkie-talkies. The units uninstalled, sell for \$34.95, postpaid.

The complete specifications on the unit are impressive and are all included in an information sheet complete with oscillograms of the audio burst envelope and output waveform. The sheet is available by writing to Ross and White Company, 50 West Dundee Rd., Wheeling, Illinois 60090 or by using *check-off* on page 126.

## The "STANDARD"

# 72' ALUMINUM Tower FOR DX'ing

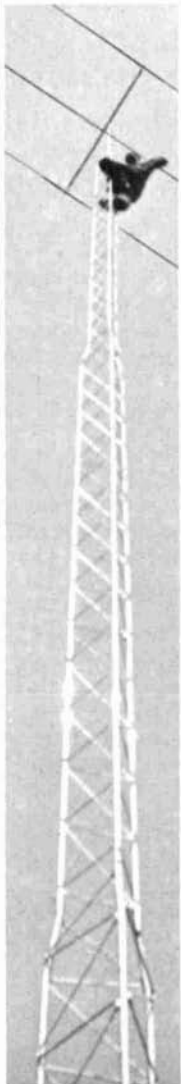

Strong, Light, No Upkeep  
Self-Supporting

Easy to Assemble & Erect

All towers mounted on  
hinged bases

Complete Telescoping and  
Fold-Over Series available

\*so light you can  
put it up all by  
yourself! No  
climbing, no jin  
poles, no heart  
attacks.

And now, with motorized  
options, you can crank it  
up or down, or fold it over,  
from the operating posi-  
tion in the house.

See your local distributor, or write for 12  
page brochure giving dozens of combina-  
tions of height, weight and wind load.

## HEIGHTS MANUFACTURING CO.

NOW In New Larger Facilities  
In Almont Heights Industrial Park  
Almont, Michigan 48003

# DRAKE ML-2

## EXCEPTIONAL QUALITY... VHF FM Transceiver



Including transceiver, 3 channels supplied, mobile mount, dynamic mike and built-in AC-DC power supply.

**\$299<sup>95</sup>** Amateur Net

Accessory BBLT-144D Antenna:  
Hustler 3.4 dB gain \$27.95

**GENERAL** • Freq. coverage: 144-148 MHz • 12 channels, 3 supplied • Push-to-talk Xmit • AC drain: Rcv, 6W; Xmit, 50 W • DC drain: Rcv, 0.5A; Xmit, 4A • Built-in Power Supply: AC, 117V 50-60 Hz; DC, 13.5V±10% • Size: 7-7/8" x 2-3/4" x 10-1/4", 8-1/4 lbs.

**TRANSMITTER:** • Transistorized with 6360 output tube • RF Output: over 10 W • Freq. Dev: Adj. to 15 kHz max. • Freq. Stability: ±.001% or less • Output Imped: 50 ohms.

**RECEIVER:** • Completely transistorized, crystal-controlled superhet • Interm. Freq: 1st 10.7 MHz, 2nd 455 kHz • Input Imped: 50 to 75 ohms • Sensitivity: 0.5µV or less/20 dB quieting; 1µV or less/30 dB S+N/N at 10 kHz dev., 1 kHz mod. • Audio Output, 0.5 W • Spurious Sens., > -60 dB.

**R. L. DRAKE COMPANY**



**DRAKE**®

540 Richard St., Miamisburg, Ohio 45342  
Phone: (513) 866-2421 • Telex: 288-017

### New 3 Digit Counter



The model fm-36 3-digit frequency meter has the same features that has made the 2 digit model so popular with Hams — low price, small size (smaller than a QSL card), 35 Mhz top frequency, simple connection to your transmitter, +0 -0.1 KHz readout — PLUS the added convenience of a third digit to provide a 6 digit capability. Kit or Assembled.

Example: 28,649,800 Hz reads 28.6 MHz or 49.8 KHz. (Add the 10 Hz module to read 9.80.)

FM-36 KIT \$134.50

NEW . . . . .

300 MHz PRESCALER only \$45.00  
with fm-36 order

**Micro-Z Co.**

Box 2426 Rolling Hills, Calif. 90274

### CIRCUIT BOARDS in 10 Minutes

with just a pair  
of scissors



#### Pressure Sensitive Copper Foil Tape and Sheet

- No Chemicals — No Mess
- No Layout Restrictions
- Full Instructions
- Simple Circuit Changes
- Flexible — Conforms to any surface shape
- Use for Crossovers — Either insulate with Teflon or Mylar or use other side of board.

5 feet 1/16" or 1/8" wide ..... \$6.00

100 feet 1/16" or 1/8" wide ..... \$9.95

Sheets 6" x 12" — \$2.50 each  
or 5 for \$9.95

Order Now

**Cir-kit**

Division of PHASE CORPORATION  
315A Boston Avenue  
Medford, Mass. 02155

limited to, young people. Assuming no previous technical understanding by the reader, it thoroughly explains the fascination of amateur radio, the jargon, the gear necessary, how to get a license, learn the code, select gear, erect an antenna, use simple test gear and acquire good operating procedure. All in all it answers any conceivable question that the neophyte might have. There are also two chapters devoted to careers for amateurs in the military, industry and broadcasting.

This book should be in every town library and certainly in every high-school library. It would be handy in the ham shack to lend to inquiring neighbors, newspaper boys and coworkers. If you think there is a likely candidate to become a ham, giving him this book just might do the trick. Softbound, 185 profusely illustrated pages, \$5.25 from Comtec Books, Greenville, New Hampshire 03048.

## burglar alarm



Intended for many installations, but particularly suitable to protecting mobile rigs, the new ECD siren module offers the heart of an effective car burglar alarm system. The siren module kit contains a pre-assembled module which emits a two-tone wailing audio sound rated at 96 dB at 25 feet (10 watts output) when run on 12 volts. It can also be run on 6 volts, however. Also in the siren kit are a projection speaker, a 6 volt battery, 100 feet of hookup wire and instructions. The system sells for \$24.95 plus postage. The pre-assembled module alone costs \$14.95.

For more information write to Electronics Circuits and Design Company, Inc., 33 East Chestnut Street, Alliance, Ohio 44601 or use *check-off* on page 126.

## logic checker

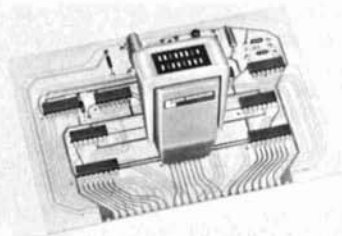

A small, portable, passive logic checker has been introduced by ALCO Electronic Products. The Model 101 Logic Checker gives instantaneous visual indication of the logic states of all terminals on TTL and DTL 14- and 16-pin dual-in-line integrated circuits.

The 101 is totally self-contained and requires no batteries or power cords—it is powered by the circuit under test. A bank of small incandescent lamps on the top of the unit along with a set of 24 templates covering virtually all popular IC packages display and interpret the logic levels present on all terminals as long as the package uses standard logic voltages between 0.5 and 5 Vdc.

The unit's overall dimensions are 1.7 x 2.65 x 1.35-inches. The complete specification sheet on the unit is impressive and is available from Alco Electronics Inc., Box 1348, Lawrence, Massachusetts 01842 or by using *check-off* on page 126. This handy piece of test equipment sells for \$89.95.

## introduction to ham radio

How do you explain to a curious youngster what our hobby is all about? How do you explain the difference between CB and amateur radio, or how do you interpret ham jargon? It can take a lot of explaining and it can get pretty confusing to a young person. Robert Hertzberg, W2DJJ, has come out with the fifth edition of, "So you want to be a Ham," and this time-tested manual goes a long way toward telling the prospective amateur all about the hobby.

With hundreds of photographs, this book is written for, but definitely is not

FREE TELREX BROCHURE AVAIL.

SPECIFY AREA OF INTEREST

FOR EXPANDED INFO

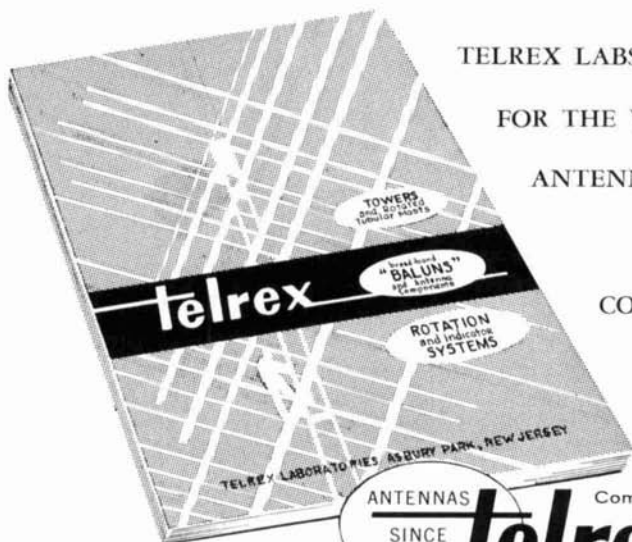

TELREX LABS

FOR THE VERY BEST

ANTENNAS AND SYSTEMS

AMATEUR

COMMERCIAL, MILITARY

CB OR TV

ANTENNAS

SINCE  
1921

Communication and TV Antennas  
**telrex** LABORATORIES

ASBURY PARK

NEW JERSEY, U.S.A.

## HAM RADIO CENTER

*Announces!*



**NOW:** Call your order in, and we'll pick up the tab for the phone call. (Minimum order \$10.00)

**HOW:** Place station to station call. When phone bill is received, forward copy along with our invoice covering order phoned in, we'll send refund check. **DO NOT CALL COLLECT.**

**PLUS:** We will ship your order PREPAID if destination is in our UPS surface shipping area. (Limit-108" width & girth combined and 50 lbs. max. wt.)

**COMPLETE STOCKS ALL NATIONAL BRANDS  
WE BUY-SELL-TRADE USED EQUIPMENT**

Write for List

**HAM RADIO CENTER, INC.**

8342 Olive Bl., St. Louis, Mo. 63132

Phone (314) 993-6060

## SAROC

HELD ANNUALLY IN LAS VEGAS, NEVADA



SEE YOUR FAVORITE AMATEUR MAGAZINE FOR FURTHER DETAILS  
OR WRITE

**SOUTHERN NEVADA AMATEUR RADIO CLUB, INC.**

P.O. BOX 73, BOULDER CITY, NEVADA 89005

## ic electronic key

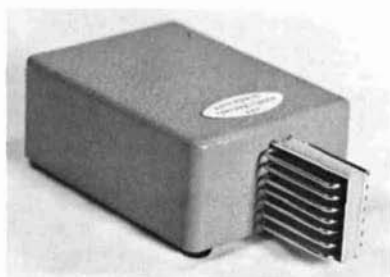

The Electronic Feather Touch Key is a completely solid-state key without paddle movement, spring tension or contact clearance adjustments or any keying contacts. Keying problems caused by contact corrosion and bounce as well as paddle tension and movement adjustments are no longer a concern. The key is the natural interface for the extremely low current, high speed integrated circuits used in solid-state electronic keyers.

The Electronic Feather Touch Key is essentially an electronic single-pole double-throw switch activated by finger touch. Touching the electronic grid paddle causes a silicon monolithic integrated level detector to conduct. Conduction of each level detector causes its output to remain at ground potential as long as a high-impedance short (finger) remains across two adjacent grids. The design of the grid paddle prevents erratic keying due to finger moisture.

The small size key was designed specifically to meet the needs of today's solid-state keyers and to eliminate those problems experienced with mechanical keys.

The key is built on a glass epoxy board housed in an attractive light blue cabinet. It can be powered by internal batteries or 3 to 4.5 Vdc at 10 mA can be taken from a keyer. The unit is weighted to keep it in place during operation. The new key is guaranteed for a year and sells for \$19.95 wired and tested. More information is available from Data Engineering, Inc., Box 1245, Springfield, Virginia 22151, or use *check-off* on page 126.

## fet vom



The new Delta model 3000 fet vom is billed as the bridge between the multimeter and the digital voltmeter. It features ten-turn adjustment potentiometers for zeroing and ohmmeter adjustment; 10 megohm input impedance, and a variety of meter ranges which will read resistance from zero to a billion ohms, current from one nano-ampere to 300 milliamperes and both ac and dc voltages from 0.3 volts to one kilovolt.

The metering circuit incorporates a lot of innovations for a \$74.95 ready-built unit (\$59.95 kit). The meter is in the feedback loop of an ic operational amplifier which, among other benefits, minimizes nonlinearity in ac readings. There is current limiting in the ohmmeter circuit to prevent destruction of most semiconductors under test. There is also an R-C filter in the dc metering circuit to minimize inaccuracies due to stray rf pickup. The meter itself is a six-inch D'Arsonval mirror-back movement.

For complete information on these meters — this description just scratches the surface — write to Odyssey Equipment Company, Box 3382, Madison, Wisconsin 53704 or use *check-off* on page 126.

# THE VANGUARD FREQUENCY SYNTHESIZER

**YOU'LL NEVER  
HAVE TO BUY  
CRYSTALS  
AGAIN**



**MODEL: ST-140**

**SIZE: 1½" HIGH x 3⅝" WIDE  
x 8" LONG**

**PRICE:**

**\$119.95 ppd.**

**NOTE: NY State residents add sales tax.**

• 1000 channels from one crystal (yes, that's one thousand) selectable every 10 KHz. from 140.00 to 149.99 MHz.

• Better than .0005% (5 parts per million) from -10° to +60°C down to -30°C with accessory heater available later.

• Thumbwheel switches with digital readout for fast selection.

• Uses a super precision crystal reference source operating at 5 MHz. for easy checking with WWV. RF output is obtained from a VCO tightly locked to the reference source in a digital phase-locked loop circuit.

• Present model is available with output in the 6, 12 or 18 MHz. band (corresponding to 144 MHz). for direct substitution of transmitting crystals. Built-in computer selects the appropriate frequency when you set the readout to the transmitter output you want.

• Changes frequency almost as fast as you can switch. Settling time is in milliseconds even when switching from one band limit to the other. No hunting or false locks as with some other synthesizers.

• Operates from 10 to 15 VDC. Includes 3 precision IC voltage regulators (one for each major circuit function) to prevent interaction and to take care of those wide voltage swings in mobile installations. Can also be used on 110 volts AC with a small 12 volt ½ amp power supply.

**COMING SOON:** A frequency synthesizer for 45 MHz. receive crystals, a combination transmit and receive synthesizer, a synthesizer with direct output in the 144 and 220 MHz. band, and a whole series of synthesizers to cover from sub-audio to microwave frequencies. **IMPORTANT:** When ordering be sure to state if you want the 6, 12 or 18 MHz. output.

**VANGUARD LABS • 196-23 Jamaica Ave. • Hollis, N. Y. 11423**



**CAMP ALBERT BUTLER INVITES  
HAM RADIO ENTHUSIASTS OF ALL AGES**

*TO TRY FOR YOUR*

**GENERAL CLASS TICKET**

*This Summer! Our 13th Season*

**STUDY INSTRUCTION  
LEADING TO GENERAL ADVANCE  
and AMATEUR EXTRA LICENSE**

This co-ed Amateur Radio Camp, Y.M.C.A. owned and operated, can accommodate 60 campers. There is no age limit. We have had campers from 7 through 74 years of age. It is very helpful if you can copy Swpm or have a Novice or Technician ticket but it is not necessary. Time is divided between radio classes in code and theory and usual camp activities, such as swimming, archery, riflery, hiking, etc. Golf privileges are included at the beautiful New River Country Club course.

Entire staff consists of licensed hams who are instructors in electrical engineering in some of our finest colleges and universities. Camp opens July 29th and closes August 12th. Tuition of \$200.00 includes all camp expenses: room, meals, notebooks, textbooks, and insurance. Send for our brochure.

**C. L. Peters, K4DNJ**  
General Secretary  
**Gilvin Roth Y.M.C.A., Elkin, N. C. 28621**  
Please send me the Booklet and Application Blank for the Camp Albert Butler Radio Session.  
NAME .....  
CALL .....  
ADDRESS .....  
CITY ..... STATE ..... ZIP .....

**"CHOICE OF THE DX KINGS"**



All models available "WIDE-SPACED"

**2 ELEMENT—3 BAND KIT SPECIAL**  
CONTENTS ONLY

- 8 Fiberglass Arms—skyblue color
- 2 End Spiders (1 pc. castings)
- 1 Boom/Mast Coupler—h.d. aluminum
- 16 Wraplock Spreader Arm Clamps Add \$7.50 for PPD
- 1 CUBEX QUAD Instruction Manual Frt. Cont. U.S.

**\$69.95**

2-3-4 or more element Quads available  
Write for FREE BROCHURE 'H' & Price List

**CUBEX COMPANY**

P.O. Box 131, Altadena, California 91001  
Phone: (213) 798-8106

YOU CAN'T SAY "QUAD" BETTER THAN "CUBEX"



## computer electrolytics



To meet changing requirements for higher-capacitance, smaller-size capacitors in computer power supplies, industrial control equipment and energy-storage applications, a series of 190 extended capacitance ratings has been added to the Sprague Type 36D Powerlytic aluminum electrolytic capacitor line.

Some of the new capacitors feature up to 90% more capacitance in a given case size than was previously available. Type 36D Powerlytic capacitors now have a capacitance range from 50 to 650,000  $\mu\text{F}$ , with voltage ratings from 3 to 450 Vdc.

Other features include increased ripple current capability, low leakage currents, operation at 85°C without derating and extremely long shelf life.

Type 36D Powerlytic capacitors are available for off-the-shelf delivery from Sprague industrial distributors. For further information write to Sprague Products Company, North Adams, Massachusetts, 01247 or use *check-off* on page 126.

## magnetic nutdrivers

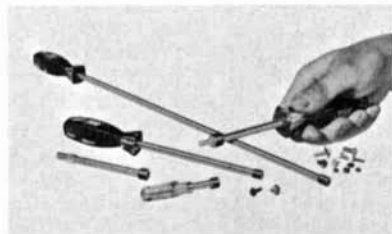

Amateur experimenters, along with professional service men may benefit from the addition of 1/4- and 5/16-inch hex socket magnetic nutdrivers to Xcelite's line of professional hand tools.

The magnetic feature is being offered on midget pocket clip, regular, extra long, and super long fixed handle drivers and also on interchangeable shanks for use with the Xcelite Series "99" handles, both regular and ratchet types.

An Alnico permanent magnet inserted in the socket holds fasteners firmly for one-hand starting, driving or retrieving hex screws, bolts and nuts, in close quarters and hard-to-reach places. The magnet is insulated so that the tool socket itself remains unmagnetized and will not attract extraneous matter or be deflected by nearby metal surfaces. Nut-driver sockets are specially treated and hardened to withstand severe service, such as the driving of hex head self-tapping screws. They are finished in black oxide for dimensional control as well as for quick identification as magnetic tools.

Fixed handle drivers have color-coded plastic handles in a new comfort-contour design. This further distinguishes the magnetic from regular Xcelite nutdrivers and provides adequate torque for one-hand driving. American made, the magnetic nutdrivers are available nationwide through local distributors. Complete information may be obtained by requesting bulletin 671L from Xcelite Incorporated, Orchard Park, New York 14127 or by using *check-off* on page 126.

## ic op amp book

Theory, circuitry and applications of the increasingly important integrated-circuit operational amplifier are covered in a new book by Roger Melen and Harry Garland. "Understanding IC Op Amps" contains chapters on the ideal op amp, real-life limitations of actual op amps, basic semiconductor theory, op amp circuitry, practical design considerations and basic op amp terms and definitions. Many practical circuits — complete with component values — are included in this book.

Published by Howard W. Sams. 128 pages, softbound; the book is available for \$3.95 from Comtec Books, Greenville, New Hampshire 03048.



## bind 'em and find 'em

Bind your HAM RADIO'S with our handsome Ham Radio Binders then find the articles you want with our new 1968-71 Cumulative Index covering every article published in HAM RADIO from our first issue through December 1971.

Of course, if your shack is like ours you may have to find'em, bind'em and find it, but that's what this is all about. Get organized. Get maximum use from your HAM RADIO collection.

### HAM RADIO GREENVILLE, NH 03048

Please send:

- ..... Binders at \$3.95 ea.
- ..... 3 Binders for \$10.00
- ..... Cumulative Index at \$1.00
- ..... Super Package-5 Binders plus Index  
An \$18.90 value only \$17.00

Name ..... Call .....

Address .....

Zip .....

## frequency marker standard



Data Engineering has introduced a frequency marker standard with a choice of seven different marker frequencies: 5, 10, 25, 50, 100, 200 and 400 kHz. Harmonics are usable above 50 MHz, and units have a front-panel adjustment for calibration against WWV. The square-wave output features better than 10-nanosecond rise and fall time and 3.8-volt peak-to-peak output.

The Data Engineering FMS-3 can be used to calibrate receivers, grid dippers, signal generators and oscilloscopes. It can be used in testing amplifiers for damping, ringing, frequency response and bandwidth. The unit also makes an accurate and stable square-wave generator capable of driving the most demanding logic circuits.

The circuit of the FMS-3 includes a precision 400-kHz crystal and a complement of Fairchild ICs. It is designed to give usable outputs above 50 MHz yet eliminate unwanted markers. Units are guaranteed for one year, are built on glass epoxy boards and come in an attractive blue and gray cabinet. The factory assembled and aligned version sells for \$32.95. The identical circuit — wired, tested and calibrated but without the cabinet, switch and battery holder is priced at \$22.95; the complete kit without the cabinet, switch and battery holder sells for \$19.95.

More information is available from Data Engineering Incorporated, Box 1245, Springfield, Virginia 22151 or by using *check-off* on page 126.

**March 1968 (first issue)**

**FEATURING:** 5-band SSB exciter, IC-regulated power supply, Remotely-tuned 10-meter beam, Transistor curve tracer, Double-balanced mixers.

**May 1969**

**FEATURING:** Potpourri of integrated-circuit applications, FM repeater receiver performance, RTTY converter, IC noise blanker, The ionospheric e-layer.

**June 1969**

**FEATURING:** Solid-state single-band SSB transceiver, External-anode tetrodes, FM communications receiver, RTTY tuning unit, Top-loaded vertical.

**August 1969**

**FEATURING:** Homebrew Parabolic Reflector, Solid-state Q-Ser, Frequency calibrator with mos IC's, New multiband quad antenna, Troubleshooting with a scope.

**September 1969**

**FEATURING:** FM techniques and practices, IC power supplies, 1296-MHz varactor tripler, Tunable bandpass filters, Amateur microwave standards.

**October 1969**

**FEATURING:** Hot Carrier Diodes, Low-cost linear IC's, Diversity antennas, solid-state 432-MHz exciter, Tropospheric duct communications.

**November 1969**

**FEATURING:** Op Amps . . . theory, selection & application, WWV receiver, Multiband antenna, Electronic key, Six-meter collinear.

**December 1969**

**FEATURING:** Solid-state communications receiver, Convert-ed-vee antenna, SSB monitor scope, Frequency synthesis, Slow-scan television.

**June 1970**

**FEATURING:** Communications experiments with light emitting



diodes, FM modulation standards, Designing phase-shift networks, Transistor frequency multipliers, RTTY frequency-shift meter.

**July 1970**

**FEATURING:** Inductively tuned high frequency tank circuit, Solid-state receiver, Digital frequency counter, Two-meter kilowatt, SCR-regulated power supplies, High-frequency hybrids and couplers.

**August 1970**

**FEATURING:** High-performance filter/preamplifier for vhf-uhf receivers, 100 MHz digital frequency scaler, Tunable audio cw filter, Stable solid-state vfo, Cubical-quad antenna design.

**September 1970**

**FEATURING:** An IC balanced modulator, Mainline ST-5 RTTY demodulator, FM receiver, RF impedance bridge, Electronic counter dials, Reactance nomograph.

**October 1970**

**FEATURING:** An swr meter for accurate rf power measurements, Direct-conversion receiver, IC voltage regulators, 432MHz converter, Introduction to thyristors.

**December 1970**

**FEATURING:** SSB generator, RF interference, Antenna bridge, QRP transmitter, AFSK oscillator.

**January 1971**

**FEATURING:** ST-6 RTTY demodulator, Intermittent voice operation of power tubes, 8873 zero-bias triode, Frequency meter, 229-MHz linear.

**February 1971**

**FEATURING:** Etched-inductance bandpass filters and filter-preamps for 50 and 144 Mhz, Six-meter linear, Speech clipping, Fet transmitters, Six and two meter mosfet converters, Incremental tuning.

**April 1971**

**FEATURING:** Inductors, VHF and UHF coil-winding data, Using ferrite and powdered cores, FM control head, Power fets, Five-band linear amplifier.

**June 1971**

**FEATURING:** A practical approach to 432-MHz SSB, FM carrier-operated relay, Audio agc systems, Practical IC's, Low-noise 1296-MHz preamp.

**July 1971**

**FEATURING:** IC receiver for 80 meters, Two-meter fm transmitter, Modern phone patch, Slow-scan television converter, Six-meter antenna tuner.

**September 1971**

**FEATURING:** Practical Photofabrication of Printed-circuit boards, Injection lasers, FM sequential encoder, Multimode i-f system, RTTY afc, IC phase-locked loops.

**October 1971**

**FEATURING:** FM transmitter for 2 meters, CW signal processor, Antenna stress analysis, Series-tuned pi networks, Phase locked loop experiments.

**December 1971**

**FEATURING:** Diversity receiving systems, IC speech processor, RTTY speed conversion, 220-MHz power amplifier, 2 meter transceiver.

There's no place like a good collection of HAM RADIO back issues to find answers you're looking for. Go over the list above and find the ones you need.



Just .75 each ppd. worldwide.

Enclosed is.....for the issues I have checked.

Name..... Call.....  
Address.....  
City.....  
State..... Zip.....

- March 1968 (first issue)
- May 1969
- June 1969
- August 1969
- September 1969
- October 1969
- November 1969
- December 1969
- June 1970
- July 1970
- August 1970
- September 1970
- October 1970
- December 1970
- January 1971
- February 1971
- April 1971
- June 1971
- July 1971
- September 1971
- October 1971
- December 1971

# YOU DESERVE THE ULTIMATE . . . REMOTE CONTROL

ONLY SWAN ELECTRONICS GIVES YOU THIS CONVENIENCE IN A

# MULTI-BAND MOBILE ANTENNA



Model  
**55B**

Patent No's.  
2961657  
3614574

Swan's remotely controlled Mobile 55B is the *ONLY* deluxe High Q automatic band-switching antenna available!

Convenient finger-tip control allows you to change meter bands while driving. Swan's patented automatic motor drive control unit covers 10, 15, 20, 40 and 75 meters; and, an indicator light tells you when you're ready to transmit.

Power rated at 1000 watts P.E.P., the Mobile 55B is top quality throughout . . . gold plated contacts . . . exclusive LEXAN unbreakable center post . . . 6 foot adjustable whip . . . high radiation efficiency . . . will not heat up . . . Kwik-On connector . . . and all the experience and skill that Swan has become famous for in the antenna field.

**SWAN MOBILE 55B ANTENNA, \$99<sup>00</sup>**  
with cable and control included . . . .

If you prefer an economical version of the Mobile 55B, you can choose the manually adjustable Mobile 45 antenna which offers rapid band-switching without the need to remove and change coils . . . . . **\$69<sup>00</sup>**

For single band operation, try Swan's 2000 watts P.E.P. Mobile 35 antenna line. Select the combination that suits you best. To get the complete details on all Swan antennas and accessories, like extra Kwik-On antenna connectors and deluxe bumper mounts, see the **1972 Spring Catalog.**



Model  
**45**

Patent No.  
2961657

USE YOUR SWAN REVOLVING CREDIT SERVICE ACCOUNT AT 10% DOWN

**SWAN**  
ELECTRONICS Dept. H  
A Subsidiary of Cubic Corporation

• 305 Airport Road • Oceanside, CA 92054 • Phone (714) 757-7525

**ECONOMICAL  
FULL PERFORMANCE  
PRECISION TUNED  
RELIABLE**

**4 ELEMENT MODEL TB-4H**

Mechanically designed for heavy duty, this rugged 4 element model will easily shrug off 100 mph winds. You have 4 working elements on each band . . . 10, 15 and 20 meters . . . that will give you reliable service in any kind of weather from the arctic to the tropics. Average forward gain is 9 db with a front to back ratio of 24 to 26 db.



**\$129.**  
TB-4H

**3 ELEMENT MODEL TB-3H**

This husky model was designed to withstand winds of hurricane force and/or heavy ice loading conditions. A lighter duty rotor than that required for the TB-4H may be used. With an average forward gain of 8 db and a front to back ratio of 20 to 22 db, here is an excellent "all around" performer.



**\$109.**  
TB-3H

**\$94.**  
TB-3

**TB-3.** If you live in an area that does not suffer extreme weather conditions, you'll find the TB-3 highly satisfactory. Forward gain is 7.5 db and front to back ratio is 20 to 22 db in this antenna that will survive through 80 mph winds.

**2 ELEMENT MODEL TB-2**

Weighing in at just 18 pounds, this model can be a real surprise. With sufficient height, you'll put out a terrific signal. Its forward gain reads out at a 5 db average. Front to back ratio is 16 to 18 db.



**\$79.**  
TB-2



**GOLDEN SWAN THE FINEST TRAP  
VERTICAL  
ANTENNA**

Featuring patented large High Q traps, that are precision tuned at the factory, the **GOLDEN SWAN** provides the maximum performance obtainable in any trap vertical antenna. Your signal power is radiated instead of dissipated in heating up the coil. 2000 watts P.E.P. Extremely low SWR across the entire band. Heavy duty mechanical design gives a 100 mph wind survival rating to this omni-directional antenna.

10, 15, 20  
and  
40 METERS

**\$49.<sup>00</sup>**

75 Meter Add-On Kit **\$29.**

**WRITE FOR YOUR COPY OF SWAN'S 1972 SPRING CATALOG**



305 Airport Road • Oceanside, CA 92054 • Phone (714) 757-7525

Here's a veritable

# Vanguard of Values...

## RECEIVERS



### VHF FM RECEIVER

11 CHANNELS • 135-250 MHz

- 11 crystal-controlled channels.
- Available in your choice of frequencies from 135-250 MHz in any one segment from 1-4 MHz wide.
- I. F. bandwidth (channel selectivity) available in your choice of  $\pm 7.5$  kHz or  $\pm 15$  kHz.
- 8-pole quartz filter and a 4-pole ceramic filter gives more than 80 dB rejection at 2X channel bandwidth.
- Frequency trimmers for each crystal.
- 2 to .3  $\mu$ volt for 20 dB quieting.
- Dual-gate MOSFETS and integrated circuits.
- Self-contained speaker and external speaker jack.
- Mobile mount and tilt stand.
- Anodized alum. Case, 6" x 7" x 1 3/8".

Model FMR-250-11 price:

135-180 MHz ..... \$109.95

181-250 MHz ..... \$119.95

Price includes one .001% crystal. Additional crystals \$6.95 each.

#### HOW TO ORDER:

State model, input and output frequencies and bandwidth where applicable. Remit in full, including sales tax if you reside in N.Y. State, direct to Vanguard Labs. Prices include postage by regular parcel post. For air mail or special delivery include extra amount; excess will be refunded.

## PRE-AMPS



### HIGH GAIN • LOW NOISE

35 dB power gain, 2.5-3.0 dB N.F. at 150 MHz, 2 stage, R.F. protected, dual-gate MOSFETS. Manual gain control and provision for AGC. 4 3/8" x 1 7/8" x 1 3/8" aluminum case with BNC receptacles and power switch. Available factory tuned to the frequency of your choice from 5 MHz to 350 MHz with approximately 3% bandwidth. Up to 10% B.W. available on special order.

Model 201 price: 5-200 MHz \$21.95

201-350 MHz \$24.95



### UHF 3 to 5 dB MAX. N.F. 20 dB MIN. POWER GAIN

The Model 202 uses 2 of T.I.'s super low noise J-FETS in our special circuit board design which gives a minimum of 20 dB power gain at 450 MHz. Stability is such that you can have mismatched loads without it oscillating and you can retune (using the capped openings in the case) over a 15-20 MHz range simply by peaking for maximum signal. Available tuned to the frequency of your choice between 300-475 MHz. 4 3/8" x 1 7/8" x 1 3/8" aluminum case with BNC receptacles and power switch.

Model 202 price: \$31.95



### LESS THAN 2 dB N.F. GAIN 20 dB @ 150 MHz.

SIZE: 2 1/2" X 5/8" X 1"

Features a super low noise J-FET rated by T.I. as typically 1.2 dB N.F. @ 150 MHz (transistor data curves supplied with unit) and guaranteed by our lab to give under 2 dB actual N.F. in our circuit. Transistor is mounted in a socket with gold plated contacts. 4 precision trimmers make possible tuning for optimum desired results over a wide range of conditions. We supply it tuned for minimum noise figure across 50 ohms input and output resistance. Fully shielded in aluminum case with feed-thru solder terminals. Supplied with mounting kit for installing inside or outside your receiver. Tuned to the frequency of your choice from 135 MHz to 250 MHz with approximately 2-4 MHz bandwidth.

Model 102 price: \$19.95

# Vanguard Labs

196-23 JAMAICA AVE.  
HOLLIS, N.Y. 11423

# M ore...

## CONVERTERS



### 40 dB GAIN 2.5-3.0 N.F. @ 150 MHz

2 R F stages with transient protected dual-gate MOSFETS give this converter the high gain and low noise you need for receiving very weak signals. The mixer stage is also a dual-gate MOSFET as it greatly reduces spurious mixing products — some by as much as 100 db over that obtained with bipolar mixers. A bipolar oscillator using 3rd or 5th overtone plug-in crystals is followed by a harmonic bandpass filter, and where necessary an additional amplifier is used to assure the correct amount of drive to the mixer. Available in your choice of input frequencies from 5-350 MHz and with any output you choose within this range. The usable bandwidth is approx. 3% of the input frequency with a maximum of 4 MHz. Wider bandwidths are available on special order. Although any frequency combination is possible (including converting up) best results are obtained if you choose an output frequency not more than 1/3 nor less than 1/20 of the input frequency. Enclosed in a 4 3/8" x 3" x 1 1/4" aluminum case with BNC receptacles, power and antenna transfer switch.

Model 407 price: 5-200 MHz \$42.95  
201-350 MHz \$44.95

Prices include .005% crystal. Additional crystals \$5.95 each.



### UHF 20 dB MIN. GAIN 3 to 5 dB MAX. N.F.

This model is similar in appearance to our Model 407 but uses 2 low noise J-FETS in our specially designed RF stage which is tuned with high-Q miniature trimmers. The mixer is a special dual-gate MOSFET made by RCA to meet our requirements. The oscillator uses 5th overtone crystals to reduce spurious responses and make possible fewer multipliers in the oscillator chain which uses 1200 MHz bipolars for maximum efficiency. Available with your choice of input frequencies from 300-475 MHz and output frequencies from 14-220 MHz. Usable bandwidth is about 1% of the input frequency but can be easily retuned to cover more. This model is now in use in many sophisticated applications such as a component of a communications link for rocket launchings.

Model 408 price: \$51.95  
.005% crystal included.

**VANGUARD LABS** 196-23 JAMAICA AVE.  
HOLLIS, N.Y. 11423

## house wiring guide

Too often amateurs tend to regard house wiring as requiring only common sense and Ohm's law. "House Wiring," the latest in the Audel series of technical books, explodes this myth by explaining the planning and actual installation which produces a safe and functional professional job. Obviously the results of years of practical experience, this book is guided paragraph by paragraph by the National Electrical Code and explains such things as the practical techniques of wiring house additions and mobile homes and adding the necessary wiring to run the highest power linear amplifier or the most well equipped workshop. Fusing, safety standards and load calculations are all included in this handy book. It showed one amateur, at least, that there is a lot more to house wiring than meets the eye.

"House Wiring" by Roland E. Palmquist is 183 pages, hardbound, and costs \$5.95. It is available from Comtec Books, Greenville, New Hampshire 03048.

## capacitor tester

The model CT-1 Capacitor Tester and Leakage Indicator allows dynamic testing of all types of capacitors for leakage, opens and shorts. The built-in power supply allows the CT-1 to safely reform aged electrolytic capacitors along with providing for dynamic capacitor testing. In addition, the unit can test vacuum tubes for inter-element leakage and open filaments. It also serves as a high-resistance continuity tester.

The CT-1 comes factory assembled with a list of applications, instructions, a test lead and power cord for \$16.95. The unit is hand held and designed for safety.

For a complete fact sheet write to Lee Electronics Laboratories, 88 Evans Street, Watertown, Massachusetts 02172 or use *check-off* on page 126.



## Go all the way into the **REPEATER**

There's nothing half-way about the new Hy-Gain *REPEATER LINE*. Designed for the man who demands professional standards in 2 meter mobile equipment, the REPEATER LINE is the 2 meter HAM's dream come true. It's got everything you need for top performance... toughness, efficiency and the muscle to gain access to distant repeaters with ease. Reaches more stations, fixed or mobile, direct, without a repeater.

The right antennas for the new FM transceivers...or any 2 meter mobile rig.

Rugged, high riding mobiles. Ready to go where you go, take what you dish out...and deliver every bit of performance your rig is capable of.

- 261 Commercial duty 1/4 wave, claw mounted roof top whip. Precision tunable to any discrete frequency 108 thru 470 MHz. Complete with 18' of coax and connector. 17-7 ph stainless steel whip.
- 260 Same as above. Furnished without coax.
- 262 Rugged, magnetic mount whip. 108 thru 470 MHz. Great for temporary or semi-permanent no-hole installation. Holds secure to 100 mph. Complete with coax and connector. Base matching coil for 52 ohm match. 17-7 ph stainless steel whip.
- 263 Special no-hole trunk lip mount. 3 db gain. 130 thru 174 MHz. 5/8 wave. Complete with 16' coax. Operates at DC ground. Base matching coil for 52 ohm match. 17-7 ph stainless steel whip.
- 264 High efficiency, vertically polarized omnidirectional roof top whip. 3 db gain. Perfect 52 ohm match provided by base matching coil with DC ground. Coax and connector furnished.
- 265 Special magnetic mount. 3 db gain. Performance equal to permanent mounts. Holds at 90 mph plus. 12' of coax and connector. Base matching coil for 52 ohm match. 17-7 ph stainless steel whip. DC ground.
- 269 Rugged, durable, continuously loaded flexible VHF antenna for portables and walkie talkies. Completely insulated with special vinyl coating. Bends at all angles without breaking or cracking finish. Cannot be accidentally shorted out. Furnished with 5/16-32 base. Fits Motorola HT; Johnson; RCA Personalphone; Federal Sign & Signal; and certain KAAR, Aerotron, Comco and Repco units.



2 meter mobile! with

**LINE** from **HY-GAIN**

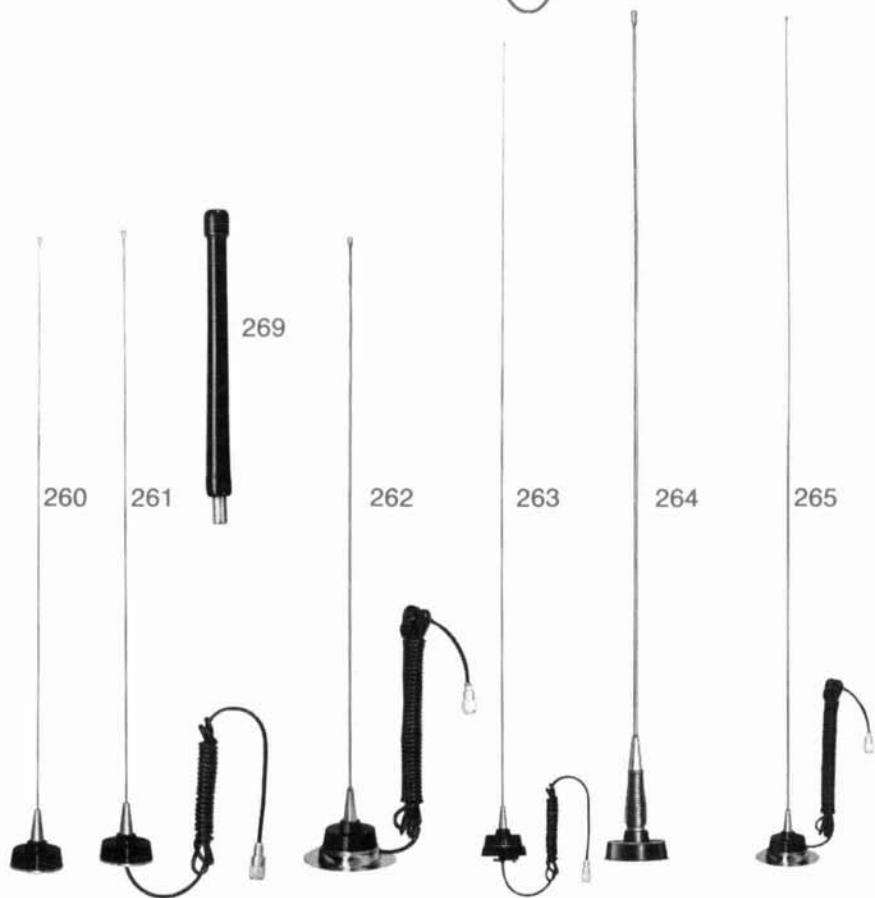

Top performance for 2 meter mobiles

**THE REPEATER LINE**

from

**HY-GAIN ELECTRONICS CORPORATION**

BOX 5407-WE LINCOLN, NEBRASKA 68505

**WRITE FOR DETAILS**

## LOOK — The CRICKET is here —

and it has the jump on all the others in its field!

This low cost keyer has more features for your dollar than all others in its price range. Even some in a higher price range! Go ahead — look around — compare the rest! Then buy the BEST — Data Engineering's new CRICKET I.

- Jam-proof spacing
- Self-completing dots and dashes
- Sidetone osc. and speaker
- Built-in key
- Relay keys 300 V at 1 amp
- Keyed time base. Instant start
- 3.5 to 50 w.p.m.
- "Full-control" weight ratio
- Speed, volume and tone controls
- Transmitter tune switch
- Auto/semi-auto. switch
- AC powered. Can also operate from 12V battery.

**\$49.95**

Why don't you get the jump on all the others — too?



## AT LAST —

### A FREQUENCY STANDARD DESIGNED SPECIFICALLY FOR THE FM'ER!

Now, for the first time, you can be exact with your channel spacing and deviation.

This deluxe marker allows you to check your receive and transmit spacing for channels in the 10, 6, 2, and 1 1/4 meter FM bands. Markers are at 5, 10, 15, 20, 30, 40, 60 and 120 KHz. Precision 12 MHz crystal. Osc. and output buffered. No unwanted markers. Rich harmonics beyond 220 MHz.

**\$44.50** (Less batteries)

Five-Year guarantee • PPD USA • Send for brochures



**DATA ENGINEERING INC.**

Box 1245 · Springfield, Va. 22151

## NEW CT-1 From

Will allow you  
to Dynamically test all  
types of capacitors.



The Model CT-1 features a built-in electronic power supply providing BOTH AC and DC Test Voltages in a special circuit with highly sensitive NEON type leakage indicator.

Only **\$16.95** postpaid

Capacitor Range: .00025 — 1000 mfd.  
Sensitivity: Over 200 MEGOHMS

30 DAY MONEY-BACK GUARANTEE

**LEE ELECTRONIC LABS, INC.**

88 Evans St., Watertown, MA 02172

Dealer Inquiries Invited.

## BULLETIN

On May 14, 1972 at 1501 GMT The Ryukyu Islands (Okinawa, etc.) will revert from U.S. to Japanese control.

Call Sign prefix will change from KR6 to KA6 for U.S. personnel.

Third party and phone patch traffic will no longer be permitted.

## NEW 2M PREAMPLIFIER

12 vdc powered

27 db gain (approximately)  
noise figure 2.5

will bring most receivers  
to .1  $\mu$ v sensitivity  
without appreciable noise.

Metal case. **ONLY \$17.95** ppd.

**CRAWFORD ELECTRONICS**

302 West Main, Genoa, IL 60135

# RADIO EXPO '72

LAKE COUNTY ILLINOIS  
FAIR GROUNDS  
JULY 8, 9, 1972  
FLEA MARKET  
6 a.m.-6 p.m.  
EXHIBITION HALL  
9 a.m.-6 p.m.

*The  
Largest Meeting  
of Radio and  
Electronic  
Enthusiasts  
in the Midwest*

Indoor Manufacturers  
Displays — Under Roof  
Giant Flea Market —  
Many Door Prizes  
— Camp Area —  
Refreshments —  
Unlimited Free Parking  
— Technical Movies  
and Seminars

#### TICKETS:

**\$2.00 for both days**

**\$1.50 (Advance sale  
price) for both days**

**Children under 12 free**

**See below for**

**Advance Gate Tickets**

#### TICKETS

**RADIO EXPO '72**  
**Box WA9ORC**  
**230 East Ontario Street**  
**Chicago, Illinois 60611**

**Offer Expires**  
**June 27, 1972**

Gentlemen: Enclosed is \$..... (Check or  
Money Order) in payment for ..... tickets  
at \$1.50 each.

Send tickets to:

Name.....

Address.....

Town.....

State..... Zip.....

Make checks payable to: Radio Expo '72



**CHICAGO**



# MINI-MITTER II SSB!

**Portable Transceiver Kit  
Handheld! QRP!**



ALL TRANSISTOR SSB TRANSCEIVER KIT DESIGNED EXPRESSLY FOR THE HAM

- \* BIG TRANSCEIVER SOPHISTICATION \* ALL SOLID STATE \* EASY TO ASSEMBLE \* SIMPLE TO OPERATE \* POWERED BY 8 NI-CAD BATTERIES
- \* RUGGED ALL METAL CASE \* 3 3/8" W X 1 3/4" D X 10" H \* WEIGHS LESS THAN 1 LBS \* PRINTED CIRCUIT BOARD \* QUALITY COMPONENTS

SSB GEAR THAT GOES WITH YOU! Introducing the new, delightfully wild MINI-MITTER II KIT designed especially for the Ham. Get it together in a few enjoyable hours of creative fun. Carefully engineered using the latest techniques this fully transistorized-solid state transceiver features commercial grade components, diode switching, a Collins Mechanical Filter along with the easy to follow instructions for assembly. The transceiver is powered by 8 Ni-Cad Batteries easily accessible through a hinged door at the rear of the case for recharging. The printed circuit board chassis and the complement of Field Effect Transistors along with integrated Circuits ensures the highest performance, yet simplifies the circuitry for easy assembly. The tune-up procedure requires no special test equipment since all of the tuned circuits are pre-tuned at the factory and need only minor adjustment. For final setting and performance checks a receiver is recommended.

RECEIVER: Crystal controlled on 40 meters, supplied with 7215 or 7255 (specify). Crystal Tuning Range: Approx. .01% of frequency. Audio Power Output: .2 watts nominal. Sensitivity: Less than 1 uv for 10 db S/N. Selectivity: 2.1 KHz at 6 db. TRANSMITTER: 4 watts P.E.P. Carrier Suppression: -40 db or better. Modulation Freq. Range: 350 to 2450 Hz. Antenna Impedance: 50 ohms relative.

- MINI-MITTER II KIT \$149.95  7215  7255.
- ACCESSORY ANTENNA \$ 7.95
- F.O.B. Mtn. View, Calif. 94040 Ca. tax 5%
- Batteries not included.
- Enclosed \$.....  BankAmericard.
- Acct #.....  Master Charge.
- NAME.....
- ADDRESS.....
- CITY..... STATE.....



GET WITH THE QRP FUN!!! ORDER TODAY!!!

1074 WENTWORTH STREET MOUNTAIN VIEW CALIFORNIA 94040

## GATEWAY ELECTRONICS

8123 PAGE AVENUE  
ST. LOUIS, MISSOURI 63130  
314-427-6116

- SILICON DIODE - 800 PIV - 50 AMP - Stud Mount - with hardware - \$1.50
- SILICON DIODE - 800 PIV - 22 AMP - Stud Mount - with hardware - \$1.00
- HEAT SHRINK TUBING - 25' Assorted Colors - \$1.00
- "TREASURE PROBE" - Metal Detector - Solid State - Ship. wt. 2 lbs. \$15.00
- CO-AX ANTENNA RELAY - 115 VAC - Constant Impedance with BNC Connectors, 1 lb. \$5.00
- 6 Volt 20 AMP LEAD ACID BATTERY - unused - Just add electrolyte - 3 1/2 x 8 x 7 1/2. 13 lbs. \$5.95
- 12 VOLT CENTER TAPPED TRANSFORMER - 3/4 AMP - 1 1/2 x 1 1/2 x 1 1/2. 1/2 lb. \$1.25
- 24 VOLT TRANSFORMER - 1/2 AMP - 2 x 2 1/4 x 1 3/4. 1 lb. \$1.00
- 24 VOLT TRANSFORMER - 2 AMP - 2 x 2 1/4 x 2 1/2. 2 lbs. \$2.00
- 125 VOLT @ 50 ma & 6.3 @ 2 AMP TRANSFORMER PA8421 Stancor. 2 lbs. \$2.00

Minimum order \$5.00. Stop in and see us when you're in St. Louis.

# HAMFEST

WESTERN N. Y.  
HAMFEST and  
VHF CONFERENCE

MAY 13, 1972

Monroe County  
Fairgrounds  
Rt. 15A  
Rochester, N. Y.  
(Near Thruway Exit 46)

- Huge Flea Market
- Top Programs
- Award Presentations
- Banquet
- Friday Night Cocktails

WRITE:  
WNY HAMFEST  
BOX 1388  
ROCHESTER, N. Y.  
14603

**HALLETT**  
**ELIMINOISE**  
 Ignition Noise Suppression Kit

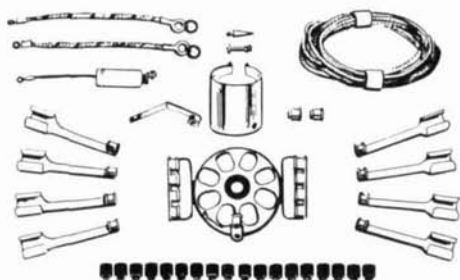

MODEL 80 - UNIVERSAL KIT FITS ALL 8 CYL. AMERICAN CARS

LIMITED

**SPECIAL \$24.95**

\$55.00 VALUE

6 and 2 Meter WHIP

MODEL LA 150

Sale Priced **15<sup>77</sup>**

Gain (2 Meters) ..... 3db  
 Gain (6 Meters) ..... Unity  
 VSWR (At resonance) ..... 1.5:1  
 Maximum Power ..... 100 Watts  
 Nominal Impedance ..... 52 ohms  
 Overall Length ..... 55 in.

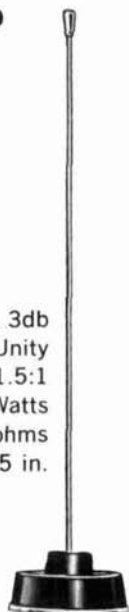

**WANTED!**  
**CLEAN DRAKE GEAR**

**REWARD:**\*

\* MUST BE CLEAN, IN GOOD OPERATING CONDITION WITH MANUALS

- \$ 195.00 — FOR YOUR 2B ON A NEW R4B @ \$ 475.00
- \$ 220.00 — FOR YOUR R4 ON A NEW R4B @ \$ 475.00
- \$ 275.00 — FOR YOUR R4A ON A NEW R4B @ \$ 475.00
- \$ 285.00 — FOR YOUR T4X ON A NEW T4XB @ \$ 495.00
- \$ 400.00 — FOR YOUR TR4 ON A NEW TR4 @ \$ 599.00

**COLLECT YOUR  
 REWARD FROM**



**Electronics Sales**

23044 S. CRENSHAW BLVD., TORRANCE, CALIF. 90505

Phone: (213) 534-4456 or (213) 534-4402



This monthly technical magazine fills a "communication gap" within the electronic communication and navigation equipment industry. Its function is to provide comprehensive and authentic information not available in any other single publication. The types of feature articles include the following:

**SYSTEM DESIGN**

The planning of radio communication and electronic navigation systems, as well as CCTV and electronic security systems.

**EQUIPMENT DESIGN**

State-of-the-art design techniques—analysis of newly developed equipment.

**TECHNOLOGY**

Reports on technical developments—looking into the future—measurement techniques.

**FCC REPORTS**

Comprehensive reports on FCC petitions, proposed rulemaking and newly adopted rules changes—long before they are published in FCC Rules and Regulations.

**SERVICING**

The latest techniques for maintaining equipment—troubleshooting—analysis and use of test equipment.

**INSTALLATION**

Solutions to unique installation problems—local and national codes—interference and interface problems.

**APPLICATIONS**

Utilization of system components—scope of equipment applications—interface requirements.

**CASE HISTORIES**

Economic and operational aspects of unique systems—examples of how problems were solved.

Subscription rate \$12 per year, \$20 for two years. When Check or Money Order accompanies subscription request, special rate is \$10 for one year or \$16 for two years. Advertising rate card sent on request.

**COMMUNICATION AND NAVIGATION, INC.**  
250 PARK AVE., NEW YORK, NY 10017

**RECONDITIONED USED GEAR**

Collins 75S-1 receiver	\$295
Collins 32S-3 trans. late	650
Collins 75A4 rec.	299
Collins KWM-2 tcvr	649
Collins 75S-3B rev. late	525
Hallicrafters SX-111 rec.	229
Hallicrafters SX-122 rec.	249
Hallicrafters HT-37 trans. SSB	179
Hallicrafters SX-99 rec.	69
Hallicrafters HT-45 lin. ampl.	199
Hallicrafters SR-42 2M tcvr.	109
Hallicrafters SX-101mk3 rec.	120
Hallicrafters HA-1 T.O. keyer	69
Hallicrafters SX-101A rec.	139
Hallicrafters HT-32 trans. SSB	169
Hamm HQ-170A-VHF rec.	249
Hamm HQ-170 rec.	139
Hamm HQ110 rec.	110
Hamm HQ-180AC rec.	329
Drake 2B rec. w/100kc cal.	179
Drake RV-4 VFO	69
Drake 2C rec.	179
Drake T4XB trans.	350
Drake CC-1 w/2 & 6M conv.	129
Heath HW-22 tcvr SSB	89
Heath HW-12A tcvr SSB	89
Heath RX-1 Mohawk rec.	119
Heath VHF-1 Seneca	119
Heath SP-630 console	59
Heath HO-13 HamScan scope	69
Heath GD-125 Grid Dip Osc.	14
Swan TCU VFO	59
Swan 140 SSB tcvr	79
Swan TV-2 2M transverter	229

Trades — Mastercharge — BankAmericard  
NEW! SIGNAL-ONE, DRAKE, ROBOT-TV, SBE, TEN-TEC, REGENCY, TRI-EX, HY-GAIN, GALAXY, ALPHA 70.

**AMRAD SUPPLY INC.**

1025 HARRISON STREET  
OAKLAND, CALIFORNIA 94607  
(415) 451-7755

**2 METER PREAMP**

More Gain, Less Noise For The Money!

**20 DB GAIN  
NOISE FIGURE 2.5  
12 VDC OPERATION**

Small Size: 1 1/4 x 2 1/4 x 1/2 - Only \$12.50

Kit \$9.50

Option for 150-250 VDC Operation - \$1.00



**BROADBAND AMPLIFIERS at a price you can afford**



The BBA-1 series offer high gain over the HF to UHF region with Noise Figures as low as 3dB max. BBA-1PB covers 30 to 400 MHz with 17dB. ±1dB. gain and 3.2dB. maximum Noise Figure. The BBA-1P covers 3 to 500 MHz. with gain between 15 and 30dB. and maximum Noise Figure of 3.0 dB. For less critical use order the BBA-1 which has the same coverage as the BBA-1P but with slightly reduced UHF gain and higher Noise Figure. They are all a bargain! BBA-1PB, BBA-1P - \$45.00, BBA-1 - \$30.00 FOB Baltimore

**RADIATION DEVICES CO.**  
P.O. Box 8450, Baltimore, Md. 21234

# FM 2 Meter UHF 6 Meter USED

GENERAL ELECTRIC ... RCA ... MOTOROLA

## GENERAL-ELECTRIC VOICE COMMANDER III

### FULL SOLID STATE FM TRANSMITTER-RECEIVER

132 to 172 MHz

Size: 9.5" x 5.3" x 1.7"

**1 WATT OUTPUT**  
**1/2 MICRO-VOLT SENSITIVITY**

High performance, completely self-contained two-way FM radio. Compact, lightweight, easily operated and hand-carried. Housed in high-impact 2-section case. All external hardware polished stainless steel.

Top section has transmitter and receiver modules, built-in mike and speaker, antenna, carrying handle, all switches and controls. Bottom section has battery power supply. Power connections to top section made by plug and jack connection.



Proper chargers available separately.

Each **\$15<sup>00</sup>**

Includes rechargeable nickel cadmium battery pack and charger.

**\$148<sup>00</sup>**

(Crystals and tuning, add \$50.)

Lots of 5 less 10% - \$133.20  
Lots of 10 less 15% - \$125.80

**15,000 2-way FM Mobile units in stock!**

**Send for new 1972 catalog.**



**GREGORY ELECTRONICS CORP.**

*The FM Used Equipment People*

241 Route 46, Saddle Brook, N. J. 07662  
Phone (201) 489-9000

**BARRY** PAYS CASH for your unused equipment, tubes, components, semi-conductors, etc. Send your list today for a fast cash offer.  
512 BROADWAY NEW YORK, NEW YORK 10012 212-WA-5-7000

**HQS for ONE of the LARGEST STOCKS of NEW & UNUSED TUBES and SEMICONDUCTORS**

Two Meter 19" Magnetic-mount whip antenna, with 10' of Amphenol coax & PL-259 Connector. @ \$99.95  
Net wt. 1 lb.

Drake "Demos": Receivers 2-C @ \$195.00, SW4-A @ \$250.00, Transmitters TR-4 @ \$465.

Dycomm Super Brick Booster; for TR-22. Typ., 30 watts out for 1W in @ \$99.95

Dycomm Brick Booster; 1W to 2W in, 20 to 25 watts out @ \$79.95

Dycomm Block Booster; 50 watts out for 10 watts in @ \$99.95

Dycomm "10-0" 100 watts out for 10 watts in typ. @ \$195.00

VHF Specialists 2M FM RF power amps. FM-3-30, 3 watts in 30 watts out typ. @ \$79.95. FM-10-50, 10 watts in 50 watts out typ. @ \$99.95.

2M Pre-amp, 13db gain, 3.5db NF. @ \$12.95.

IC-20 2M FM TCVR; 12 channels, 12 volt operation. With mike, mounting bracket and 3 channels supplied. 10 watts output @ \$289.00  
Rechargeable Battery Pac. @ \$49.00.

IC-3P Discriminator meter/power supply, 110 AC operation of IC-20. \$75.00

IC-21 2M FM TCVR with 24 channel operation, AC-DC power supply, Deviation meter, 3 Ch., SWR & RF power meter and R.I.T., 10 watts output. @ \$389.00

Drake TR-22 2M FM Portable, complete with mike and ni-cads. New. @ \$199.95

Hallcrafters HT-44 80-10 meter SSB-CW-AM Transmitter with PS-150-120 pwr sup. @ \$250.00

Swan 250 6 Meter SSB Transceiver, 117XC power supply & speaker. @ \$325.00

Swan "Cygnat" Transceiver with built-in 12-vdc/220AC power supply. New \$325.00.

Jennings UCSXF-2300 @ 10KV. Vacuum Vari-

able Capacitor, 50 to 2300pf. Unused, Orig. box @ \$195.

64,000 ufd/30 vdc/40 surge, computer grade capacitors. New @ \$4.95.

8000 ufd/55 vdc, New @ \$2.50

Gonset G-76 80 thru 6 meter transceiver with AC supply. @ \$130.00, DC supply @ \$55.00

Ten-Tec; RX-10 @ \$59.95, S-30 @ \$49.95, PM-3A @ \$79.95, PM-2B @ \$65.95

Robot SSTV Camera @ \$465.00, Monitor @ \$495.00, F 1.9, 25mm Lens @ \$30.00

Pearce-Simpson 25 watt 2M FM TCVR, 6 channels independent transmit and receive, 2 ch. supplied. 12 volt DC operation @ \$249.95, With AC supply @ \$299.95

Polarad Microwave Signal Generator Model SG-400 A/U, 4.2 to 11.0 KMC with direct read-out on frequency, .1uv to 200mv output, internal and external modulation and all cables, accessories and spare tubes. New @ \$795.00

**JUST ARRIVED . . .**

Eico Model 723, 60 Watt CW Transmitters: New @ \$65.00.

Collins 30-S1, Linear Amplifier Mint. Write.

Collins Power Supply - 516-F2 Parts-Components. No chassis. Write or call for details.

Collins 30-L1 Linear Amplifier. Parts-components without chassis: Write or call for details.

SBE-144. New 2 Meter FM Transceiver by SBE with dynamic mike @ \$239.95.

Call or write for information on the CX7A Transceiver and the New SBE Digital Transceiver. Also Alpha/Seventy Linear Amplifiers. Barry Electronics is also an Export company and can handle orders from all over the world. Prices FOB N.Y., N.Y. 10012.

**BARRY 512 Broadway NY, NY 10012**  
**212-WA-5-7000 ELECTRONICS**

**SPACE-AGE TV CAMERA KITS & PLANS**



BE A PIONEER IN HOME TELECASTING! Build your own TV CAMERA. Model XT-1A, Series D, \$116.95 pp. Solid-State. Step-by-step construction manual. High quality. Connects to any TV without modification. Ideal for home, experimenters, education, industry, etc.

PHONE or WRITE for CATALOG.

DIAL 402-967-0771

Many other kits, parts and plans available including starter kits, focus/dell. coils, vidicon tubes, const. plans, etc.

1301 BROADWAY, N.W. ATV Research DAKOTA CITY, NEBR. 68731

**EK-404 DELUXE KEYS \$124.95**

- ALL THE FEATURES YOU'VE ASKED FOR
- 115Vac AND +12Vdc
- READ JAN. 1972 CO AND MAR. 1972 QST FOR REVIEW OF SIMILAR EK-402 PROGRAMMABLE KEYS

WRITE FOR BROCHURES

**GURTS ELECTRO DEVICES**

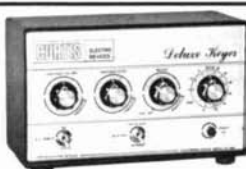

BOX 4200 • MOUNTAIN VIEW, CALIFORNIA, 94040 • TEL. (415) 964-3730

**TOROIDS — TELETYPE**  
**Lowest Prices Anywhere!**



44 or 88 mhy TOROIDS  
\$10 FOR 40  
ALL PPD U.S.

MODEL 15-19  
60 W P.M. GEAR SET  
(74V12-74V13)  
\$3.50

FRESH RIBBONS  
FIT ALL MODELS 14-15  
19-28-32-33  
\$3.50 BOX OF 12

**MANY OTHER BARGAINS—SEND FOR CATALOG**



Van's W2DLT Electronics  
302H Passaic Avenue  
Stirling, N. J. 07980  
CALL 201-647-3639



**220 MHz**

Join the action on 220MHz with the JANEL deluxe receiving converters and preamps. Extremely sensitive with freedom from spurious responses.

220CA Converter, 28-32 MHz i-f, \$69.95 ppd  
220PA Preamp, 2.5 dB NF, \$19.95 ppd

Write for full details. Other models available for 50, 144, and 432 MHz.

**JANEL LABORATORIES**

P. O. BOX 112  
SUCCASUNNA, N. J.  
07876  
(201) 584-6521



# THE FIRST OF ITS KIND!

## LED READOUT MODULE

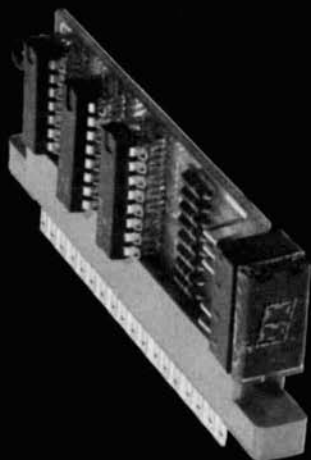

### LR-100 Series

### Unmatched Versatility at Low Cost

The LR-100 series counter/display modules have the features required for a broad range of applications. All have TTL counter, latch, decoder, and LED display, except the LR-106 which is less latch. IC and display sockets provided. All mount in standard 18 pin connector. Functions include count, reset, overflow, BCD output, strobe, zero blanking, lamp test, and decimal pt. input. Operate from 5 volts DC. LED is MAN-1 equivalent. PC board measures 3.1" x 1.25" and is double-sided with ground plane and plated conductors.

LR-110 Decade Counter .....	20 MHz .....	\$16.95
LR-110H Decade Counter.....	70 MHz .....	18.95
LR-110UD Up/Down Decade Counter .....	25 MHz .....	20.95
LR-106 Modulo 6 Counter...	20 MHz .....	14.95
PCC-18 Connector for LR-100 series .....		0.95

## Keyboards

### KB-1



### KB-2

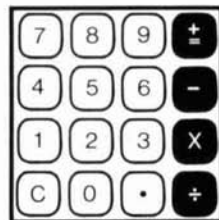

These low cost keyboards are great for home built computers, calculators, touch tone networks, etc. Each contact is rated at 40 mA and 25 V. Will interface directly with TTL, DTL, and RTL logic. Employ elastomeric principle for almost infinite life. These come directly from the manufacturer and we supply applications information. Measure 3" on a side and 1/2" deep.

KB-1 Touch Tone Format.....	\$7.95
KB-2 Calculator Format.....	7.95
Both for .....	15.95

Need a low power display? These liquid crystal displays require less than 1 microwatt per segment. Unlike other liquid crystal displays, these have fast turn-on and turn-off times, can be time multiplexed, will operate from low voltage AC or DC, can be seen in low ambient lighting, and are TTL compatible. Digits are 0.4" high and each has a decimal pt. LCR-3.5 has "+" and "-" sign and an overflow arrow. Supplied with free connector, specs & app. notes.

LCR-3.5 or LCR-4 ...specify ..... \$15.00

## Liquid Crystal Displays

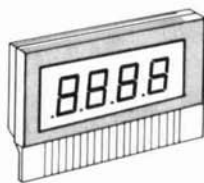

## Environmental Products

BOX 406 Lafayette, IN 47902 Ph: 317-743-1893

# ELECTRONIC SURPLUS BARGAINS

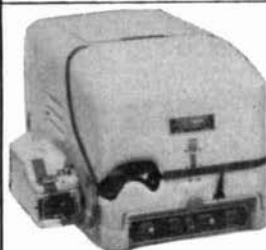

## KLEINSCHMIDT TELETYPWRITERS

Model TT-100. Capable of sending 60-100 WPM., 115 v, 60 cyc. Self contained pwr. supply. Shipping wt. 70 lbs. .... \$59.50 ea.  
 Model TT-483 - Same as above.  
 UNUSED ..... \$150.00 ea.



## REPERFORATOR-TRANSMITTER

Model TT-179/FG Mfg by Kleinschmidt  
 Tape printing & punching, also transmitter-distributor. 115 volts, 60 cyc, shpg. wt. 90 lbs. Used, excellent cond., (gov't. cost \$2,000). ..... \$59.50

## TELETYPWRITER TABLES

Heavy duty construction, shpg. wt. 20 lbs. for page printer, 22" x 18" x 27" ht. \$15.95

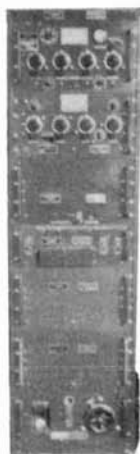

2-METER-VHF  
 BC-640 X'MITTER  
 50 watt - CW and AM.  
 Freq. range 100-156  
 MC crystal controlled  
 Pwr. rgmt. 100/125 60  
 cyc. Crated wt. 600  
 lbs. 6' x 22" wide.  
 \$49.50

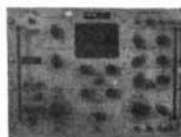

A wide-range, high gain, portable test unit for observation of pulses, short-period electrical disturbances, sine waves. Band width 3 cyc.-15 mc. 105/125 VAC. 50-1000 cyc.

AN/USM-50 OSCILLOSCOPE \$79.00

## AUDIO OSCILLATOR

TS-382-C - 20CPs to 200KC  
 Var. 0-10volts - power 110v, 60cy  
 17" x 10" x 11"  
 Shp. Wt. 45 lbs.  
 Used, good condition - \$65.00



**ANDY ELECTRONICS**

(DIV. OF ANDY INTERNATIONAL, INC.)

6427 Springer

713-645-7057

Houston, Texas 77017

Richard Hall — W5ZJG

F.O.B. Houston, Tex. — Payment with order

**15% DISCOUNT**

on

**ANTENNA, TOWER  
& ROTATOR PACKAGES  
DURING MAY**

Just because you have not seen our ad for the past year does not mean we are out of business. We've been taking care of our old customers and moving into our new warehouse and shop to better serve you. Write for New Catalog.

TRI-EX	HEIGHTS
E-Z WAY	CDR
HY-GAIN	KIRK
WILSON	NEWTRONICS
MOSLEY	CUSHCRAFT

GALAXY

**ANTENNA MART**

BOX 7

RIPPEY, IOWA 50235

Phone: 515-436-7718

QSOs  
EN  
ESPANOL

Special  
Any Course on 5" reel  
\$9  
(check)  
Spanish  
German  
Japanese

QSOs  
AUF  
DEUTSCH

Courses in Spanish, German, and Japanese designed for amateurs. Enables hams to exchange greeting and signal reports and to chat with foreign hams. Each course has many typical QSO's, technical terms, and slang. Narrated by native speakers.

**Spanish course:** 75 minutes Spanish dialogue with English-Spanish manual taped on 7" reel 3 3/4 IPS for \$11.95, on C-90 Cassette \$10.95. For **German course** running 90 mins. add \$2 to above prices. **Japanese course** 30 mins. same prices as Spanish course. Dual language manuals alone \$2.50. Mailed 3rd class in U.S. PPD. Send checks to:

Foreign Language QSOs, Box 53, Acton, Mass. 01720

## FM Schematic Digest

A COLLECTION OF  
MOTOROLA SCHEMATICS

Alignment, Crystal, and Technical Notes  
covering 1947-1960

136 pages 11 1/2" x 17" ppd \$6.50

**S. Wolf**

P. O. Box 535

Lexington, Massachusetts 02173



**News**  
**Study-Guides**  
**History**  
**Biography**  
**Projects**

**Old-Time Radio**<sup>T.M.</sup>

**SPECIAL SUBSCRIPTION RATE  
 FOR RADIO AMATEURS**  
 U.S. only **\$1.50** Per Year  
 (Published Bimonthly)

Today, more than ever before, there is a thirst for information throughout the land. Science-minded Americans, young and old alike, want to know what electronics is doing, constructively, for our environment — how it began in the past, and how it is going to shape the world of tomorrow.

Electronics Digest is the electronics magazine that answers these questions. Now in its fifth year of publication, Electronics Digest has been endorsed by many leading educators, libraries, and educational institutions throughout the U. S. and Canada.

Please enter my order (check/money order enclosed) as checked below:

**ANNUAL BOUND VOLUMES**

- Copies Vol. 1 @ \$4.95 each
- Copies Vol. 2 @ \$4.95 each

- Copies Vol. 3 @ \$4.95 each
- 3-Vol. Set @ \$12.00 per set
- 3-year SUBJECT INDEX @ \$1.50 each

Above prices for U.S., Canada and Mexico; other countries add \$2.00 U.S.

One-year subscription to the ELECTRONICS DIGEST, \$1.50

**Electronics Digest**

FORT WORTH, TX 76107  
 1024 CURRIE STREET,

Name \_\_\_\_\_

Address \_\_\_\_\_

City/State/Zip \_\_\_\_\_

# LED NEON READOUTS

Incandescent



## ALPHA-NUMERIC 7-SEGMENT READOUTS 3.95

Buy any 3 — Take 10% Discount

A Poly Pak exclusive! Two different types. Both compatible with SN7446, SN7447, SN7448, SN7475, SN7490 and SN74192 IC's. Both with decimals, 0 to 9 numerals and 10 letters. With specs & hookups. INCANDESCENT

**16-PIN MICRO MINIATURE**  
Fits into 16 pin dual in line socket. Life: 250,000 hours. Delivers 700-ft. Lamberts brightness with 5 volts 8 mils per segment. Characters .362" H. x .197" W.  SOCKET FOR ABOVE — 50c ea.

**9-PIN TUBE TYPE**  
For printed circuit board or socket. Life: 100,000 hours. Delivers 6,000-ft. Lamberts with 5 volts 23 mils per segment. Characters .47" H. x .26" W.  SOCKET FOR ABOVE — 50c ea.

## ALPHA-NUMERIC 7-SEGMENT READOUTS

2.99

Buy any 3 — Take 10% Discount

Poly Pak exclusive! Fluorescent types, MINI-7 and SLIM-7 tube types by Tung-Sol and G.E. for portable calculators, etc. Compatible to SN7446, 7, 5, 90 and SN74192. Both 0-to-9 with right decimals, with 14 letters. Readout color "blue-green". Filament 1.5 vac/dc 4 mils. Segments, 25 VDC 4 mils.

**MINI-7 — TUNG-SOL DT-1705E**  
Tube size, 1 3/4" high x .71" character size: .360 x .570", 10 pins.  SOCKET FOR ABOVE — 50c

**SLIM-7 — G.E. Y-4075**  
Tube size, 1.6" x .375". Character size: .20" x .40". Nine 2" leads.  SOCKET FOR ABOVE — 50c

## 7-SEGMENT ALPHA-NUMERIC LED READOUT 6.50

3 for \$18

0-9 numbers and 9 letters. Compatible with SN7446 and SN7447 7-segment BCD IC drivers. Snaps into dual in line sockets. Only 3/4 x 1/4 x 1/4". Specs: 5V 20 mils.  SOCKET FOR ABOVE — 50c ea.

Buy Any 3 Take 10% Discount!

## GIANT SALE ON NEW TTL TEXAS & NATIONAL IC's

Factory Guaranteed! Tested! Marked!

Type	Circuit Functions	Sale
SN7400N	Quad 2 input gate	\$0.35
SN7401N	A SN7400N, with open collector	0.35
SN7402N	Quad 2 input NOR gate	0.35
SN7404N	Hex inverter	0.35
SN7405N	Hex inverter, open collector	0.39
SN7410N	Triple 3 input NAND gate	0.35
SN7420N	Dual 4 input NAND gate	0.35
SN7430N	8 input NAND gate	0.35
SN7440N	Hex inverter	0.35
SN7441N	BCD-to-decimal decoder/driver	1.35
SN7442N	BCD-to-decimal decoder	1.35
SN7446N	BCD-to-7-segment decoder/driver	1.95
SN7447N	BCD-to-7-segment decoder/driver	1.95
SN7448N	BCD-to-7-segment decoder/driver	1.95
SN7472N	J-K Master slave flip flop	0.49
SN7473N	Dual J-K Master slave flip flop	0.62
SN7474N	Dual D triggered flip flop	0.45
SN7476N	SN7473N, with preset & clear	0.62
SN7481N	16 Bit scratch pad MEMORY	1.50
SN7483N	4 Bit binary FULL ADDER	1.55
SN7490N	Decade counter	1.40
SN7491N	8 Bit shift register	1.25
SN7492N	Divide by 12 counter	1.25
SN7493N	4 Bit binary counter	1.25
SN7494N	4 Bit shift register	1.25
SN7495N	4 Bit right shift left shift reg.	1.25
SN7496N	5 Bit shift register	1.25
SN74121	One shot multivibrator	1.00
SN74123	Dual retrig 1-s/multiv. with clear	2.50
SN74181	4 Bit arithmetic logic	7.95
SN74182	Look ahead carry generator	3.45
SN74192	Up/down decade counter	3.45
SN74193	Up/down binary counter	3.45

100 or more, 25% discount

## NATIONAL—SIGNETIC PHASE LOCK LOOPS (VCO's) 4.50

Buy 3 — Take 10%

- LM-565 Building block . . . . . \$4.50
  - SE-566 Tone generator . . . . . 4.50
  - SE-567 Touch tone decoding . . . . . 4.50
- State 1st, 2nd, choice case—TO-5 or DIP

## ALLEN BRADLEY'S 'TRANSISTOR' POTS

- Ohms Type F. Screwdriver adjust. Any
- |     |      |      |     |      |        |           |
|-----|------|------|-----|------|--------|-----------|
| 100 | 500  | 2.5K | 20K | 100K | 500K   | 2 for \$1 |
| 200 | 1.0K | 5.0K | 25K | 100K | 2 Meg. |           |
| 250 | 2.0K | 10K  | 50K | 250K | 2 Meg. |           |

## 'MICRO-POTS' 2 for \$1

- Ohms Type G, 1/2" dia., 1 1/2" high, Mounts 1/8" hole, with shaft, linear, immersion proof high temp.
- |     |      |     |      |        |
|-----|------|-----|------|--------|
| 100 | 1.0K | 10K | 100K | 1 Meg. |
| 250 | 2.5K | 25K | 250K | 2 Meg. |
| 500 | 5.0K | 50K | 500K | 5 Meg. |

## COUNTING SYSTEM

Includes SN7490, decade counter, SN7475 latch, SN7441 BCD decoder driver, 0-to-9 Nixie tube, socket & instructions.

5-Pc. Kit 6.99

3 sets for \$18.

## EPOXY SILICON RECTIFIERS \*micromini

PIV	2Amp	2Amp	3Amp
50	\$ .05	\$ .05	\$ .08
100	.06	.06	.12
200	.07	.07	.15
400	.09	.09	.22
600	.12	.12	.28
800	.15	.15	.39
1000	.18	.18	.45

## HIGH VOLT 1AMP PIV SALE

PIV	SALE
2000*	1.00
3000	1.35
4000	1.65
5000	2.25
6000	2.90
8000	3.50
10000	3.95

## WESTINGHOUSE 3.88



## SOLID STATE AM-FM TUNER

FM 88-108mhz & AM 550-1600kc, Sensitive 2 1/4 x 2 1/4 x 1 1/2" module. Can be used with 10.7mc & 455kc IF strips & any hi-fi amp. P.C.C. wired, 4-gang variable supply voltage 9V 6 mls, Varactor diode for AFC. Schematics.

## FAIRCHILD 'VISIBLE' LED's 79c

Buy 3 — Take 10% Discount! Color: Red, For readouts, panel lights, etc. TO-18 case.

6-AMP FULL WAVE BRIDGES	PIV	SALE	400	150
	50	\$ .88	600	1.75
	100	.99	800	1.95
	200	1.25	1000	2.25

## BRAND NEW! LINEAR IC AMPS

702 HI Gain, DC amp TO-5	.79	Factory Guaranteed!
703 RF-IF, 14 hookups, TO-5	1.19	
709C Operational Amp***	.59	Factory Tested!
710C Differential Amp***	.59	
711C Memory, Sense, Amp***	.59	Buy Any 3 Take 10% Discount!
723A Voltage Regulator***	1.49	
TVR-2000 Hi-power 723***	1.59	*** State 1st 2nd choice, Dual In Line, TO-5
741C Freq. Comp. 709***	.95	
748C Freq. Adjustable 741***	.95	
709-709 Dual 709's (DIP)	1.49	

## \$2.49 Fairchild 16-TRANSISTOR STEREO PRE-AMP 'IC'

LOW NOISE! Type 739. 8 transistor per channel. For magnetic stereo phono and tape recording devices. 50K input imp., 20,000 input gain. Provides RIAA band shape. Supply volts: 6 to 18V. Dual In Line

## INTEGRATED CIRCUIT SOCKETS

Buy Any 3 Take 10% Discount!	14-Pin, dual in line	\$ .45
	16-Pin, dual in line	.50
	TO-5, 8 or 10 pins	.29

15c CATALOG on Fiber Optics, 'IC's, Semi's, Parts

## POLY PAKS

Terms: add postage, cod's 25%. Rated: net 30  
Phone Orders: Wakefield, Mass. (617) 245-829  
Retail: 211 Albion St., Wakefield, Mass.  
C.O.D.'S MAY BE PHONED IN  
P.O. BOX 942H, LYNNFIELD, MASS. 01940

## SILICON TUBES

5U4	\$1.49
8R4	3.95
6X4	7.95

# flea market

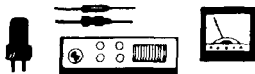

■ **RATES** Commercial Ads 25¢ per word; non-commercial ads 10¢ per word payable in advance. No cash discounts or agency commissions allowed.

■ **COPY** No special layout or arrangements available. Material should be typewritten or clearly printed and must include full name and address. We reserve the right to reject unsuitable copy. **Ham Radio** can not check out each advertiser and thus cannot be held responsible for claims made. Liability for correctness of material limited to corrected ad in next available issue. Deadline is 15th of second preceding month.

■ **SEND MATERIAL TO:** Flea Market, Ham Radio, Greenville, N. H. 03048.

**ROCK RIVER HAMFEST** at Lee County 4-H Center, Amboy, Ill. Prizes, May 28, Come Early, Stay Late. Camping - no charge. Swap tables no charge (limit 3) first come, first served. Food available. Talk-in 3950 & 146.94. \$2.00 at door or \$1.50 advance from Carl Karlson, Box 99, Nachusa, Ill. 61057

**SURPLUS MILITARY RADIOS**, Electronics, Radar Parts, tons of material for the ham, free catalogue available. Sabre Industries, 1370 Sargent Avenue, Winnipeg 21, Manitoba, Canada.

**QSL'S** — **BROWNIE W3CJI** — 3111B Lehigh, Allentown, Pa. 18103. Samples 10¢. Cut catalogue 25¢.

**EXPEDITION TO NAVASSA**, Call Sign KC4DX, 2300Z, Friday, May 12, 1972. Operating 10 through 160 meters SSB and CW. SSB on the highest band open to the U.S. CW station on the next lower band. 24 hours each day from 2300Z Friday to 1300Z Monday, May 15. Frequencies approximately as follows: 28.605 mhz, 28.905 mhz, 21.355 mhz, 21.030 mhz, 14.280 mhz, 14.030 mhz, 7.255 mhz, 7.030 mhz, 3.505 mhz, 3.530 mhz. If interested send SASE to QSL address for details on 160 meters. QSL via W4GKF or to KC4DX, PO Box 11555, Atlanta, Georgia 30305. U.S. amateurs send SASE plus one (1) IRC; outside U.S. send SAE plus two (2) IRCs.

**PC BOARD MAKERS**, one square foot, 1/16 G-10 copper clad laminate, \$4.95, and — cut in the size more useful for you, add 25¢ for shipping. E.P.G., Box 68, Somerville, Mass. 02144.

**SWAN 350C** wanted, with or without power supply. W6YO, 1416 7th Avenue, Delano, CA 93215.

**2-METER FM INOUE IC-20**, Brand New, 1 & 10 watts, solid state, 12 channel, w/xtls, w/accessories, \$249.50. Bob Brunkow, 206-747-8421, 15112 S.E. 44th, Bellevue, Washington 98006.

**WEST COAST VHF/UHF Conference** May 6-7 at Ramada Inn, Santa Clara, Calif. Talks on VHF/UHF. Bring your equipment & antennas for noise & gain measurements 144-1300 MHz. Cost \$2.00. Special rates at Ramada Inn. Details from W6FZJ.

**DX'ERS** — Dig Them Out of the Mud. New low noise Dual Gate MOSFET Preamplifier. Nominal 20db gain, 10-30 MHz. Complete in cabinet \$29.96. Dynacomm, 1183 Wall Road, Webster, NY 14580.

**FREE INFORMATION.** Get FCC license new, easy way. Academy of Communications Technology, HR-2, Box 389, Roswell, New Mexico 88201.

**FOR SALE:** GR LRI Freq. Meter, Eltec "Zero Beat" freq. meter, 5 Khz. to 500 Mhz., BC-221, TS323/UR freq. meter, 20-500 Mhz., Precision E-200C Sig. Gen., Precision E-400 Sweep Gen., Precision ES-500 Scope, RCA TMV-75B Field intensity meter, 515Khz. -20 Mhz., Stoddard TS587 A/U field intensity meter, 15 Mhz.-400 Mhz., GE Progress Line VHF mobile radio, mint. cond., GE Pre Progress line, 60W, VHF, base sta. 2 radio Specialty Mfg. Co. VHF walkie talkies, H.P. 185B sampling scope, with 187C, dual trace, plug in. W. Bingham, 15 Charles St., So. Glens Falls, N. Y. 12801.

**WORLD QSL BUREAU** — See ad page 125.

**TELEPHONE EQUIPMENT:** New. Touch and Rotary Dial Telephones, Decoders. Special: STYLELINE Touch Dial handsets w/wall base \$49.95 if color not specified. Send SASE for catalog. Junction Distributors, 164 Cypress Lane, Nashua, N. H. 03060.

**VHF NOISE BLANKER** — See Westcom ad in Dec. '70 and Mar. '71 Ham Radio.

**MOTOROLA 450 MOBILES**, U44BBT, T-power transistorized mike, control head, speaker, plugs, no cables. Excellent condition. \$75.00 FOB Buffalo. B. Sanders WA2EGW, 404 Cayuga Creek Road, So. Cheektowaga, N. Y. 14227.

**INSTANT NOISE LIMITER MODULE** — Easy 20-Minute installation for Heathkit, Galaxy, Swan and most other amateur equipment; \$8.95 Postpaid. Welborn Electronics, 133 Linden Street, Henderson, Nevada 89015.

**SELL SWAN 250C** with 117AX power supply \$300. Also Gonset GSB-2SSB 2 Mtr with both 110AC and 12VDC factory supplies \$250. Both good and working. No trades or counter offers. Will deliver up to 200 miles or ship at your cost. Robert Monroe, WB9EIP, 1770 Spittler Dr., Decatur, Ill. 62521. Ph. 1-217-422-2756.

**FIRST \$250** takes SWAN 350 and AC power supply. Works perfect — xtal. Cal. — new tubes — spare finals — manual. Days 313-664-6966. Evenings 313-664-8293. Edward Oyster, W8NCJ.

**WARREN ARA'S FAMOUS HAMFEST**, now family style, Aug. 20, Yankee Lake, Ohio. Gigantic flea market, swimming, picnicking, playground, all free. Camping available. Details: QSL W8VTD.

**TV & RADIO TUBES** 36¢. FREE CATALOG. Cornell, 4219 N. University, San Diego, California 92105.

**NEW ELECTRONIC PARTS.** Buy-Sell. Free Flyer. Large catalog \$1.00 deposit. Bigelow Electronics, Dept. HR, Bluffton, Ohio 45817.

**EXCLUSIVELY HAM TELETYPE** — 19th year, RTTY Journal, articles, news, DX, VHF, classified ads. Sample 30¢. \$3.00 per year. Box 837, Royal Oak, Michigan 48068.

**THE ANNUAL HUMBOLDT Amateur Radio Club Hamfest** will be held Sunday Afternoon, May 21, at the Shady Acres City Park, Trenton, Tenn. There will be door prizes, flea market, ladies activities, and a playground for the children. For further information contact W4IGW, Edgar Holmes, 501 N. 18th Ave., Humboldt, Tenn. 38343.

**MECHANICAL FILTERS:** 455Khz. 2.1Khz \$18.95. 300Hz \$22.95. J. A. Fredricks, 314 South 13th Avenue, Yakima, Washington 98902.

**TELL YOUR FRIENDS** about Ham Radio Magazine.

# DRAKE TR-22

## Versatility plus!... in a 2 Meter FM Transceiver



### Over-the-shoulder, mobile, or at home

Completely transistorized, compact, portable. Capacity for 6 channels. Built-in telescoping antenna, and connector for external antenna. Use barefoot or with accessory amplifier. External 12 VDC or internal ni-cad batteries, built-in 120 VAC battery charger.

Complete with: Dynamic Mike, O-T-S Carrying Case, 120 VAC and 12 VDC Cords, Speaker/Headphone Plug and 10 Ni-Cad Batteries.

**\$199<sup>95</sup>** Amateur Net

AA-22 Amplifier \$149.95  
MMK-22 Mobile Mount \$6.95  
BBLT-144D Hustler Ant. \$27.95

**GENERAL:** • Freq. coverage: 144-148 MHz • 6 channels, 3 supplied • Push-to-talk Xmit • DC Drain: Rcv, 45 mA; Xmit, 450 mA • Size: 5-3/8" x 2-5/16" x 7-1/8", 3-3/4 lbs.

**RECEIVER:** • Transistorized crystal-controlled superhet • 1st IF: 10.7 MHz, 2nd IF: 455 kHz • Ant. Input Imped: 50 ohms • Sensitivity: 1  $\mu$ V or less/20 dB S+N/N • Audio Output: 0.7 W • Built-in speaker.

**TRANSMITTER** • RF Output over 1 W • Freq. Dev. adj. to 15 kHz max., factory set to 5 kHz.

**R. L. DRAKE COMPANY**



**DRAKE**

540 Richard St., Miamisburg, Ohio 45342  
Phone: (513) 866-2421 • Telex: 288-017



### FIRE & BURGLAR ALARMS

1971 Handbook & Catalog

Save  
Hundreds  
of  
Dollars

Professional equipment from famous manufacturers. Easy step by step illustrated instructions, no special tools required. Save up to 75%. This handbook is a must for every homeowner and businessman. Just \$1 cash, check or M.O.

Write W1JFT

### ALARM COMPONENT DISTRIBUTORS

33 NEW HAVEN AVE., DEPT. HR  
MILFORD, CONN. 06460

### SPEECH COMPRESSOR

INCREASED TALK POWER



Provides > 30db Volume Compression  
Clipping For Maximum Average Power  
Optimum Bandwidth Compression  
Plugs Into Present Mic Jack  
Auxiliary Input For Phone Patch  
Two Models - Mono Or Din - In-Out Switch

Price  
**\$19.95**

\*1/2 Recovery Add  
4% Sales Tax

**KS INDUSTRIES** Box 271, Melbourne, Fla. 32901

## SPRING SPECIAL

Dipole Center Connector Model  
CC-50 Waterproof connector made  
of high quality cast aluminum hous-  
ing with steatite insulation.

**WAS \$5.93 NOW \$4.95**



See your dealer or write:

Barker & Williamson, Inc.



Canal Street, Bristol, Pa. 19007

## CONNECTICUT HAMS

Visit Roger Miner's Surplus Electronics, 246 Naugatuck Ave., Milford, Conn. Ph. 877-0555. Nights 7 pm to 10 pm and all day Saturday. DRAKE TR-3 W/PS-\$350. Collins 75S1 W/NBR-\$300. HEATHKIT SB-200-\$165. SB-620-\$65. OP-1 Scope-\$90. H.P. 460b Wideband amp.-\$25. 210a Sq. W. Gen.-\$15. 522b-\$120. AMPEX FR-1100 Stereo tape rec.-\$350. 4-1000A Filament Trans 7.5 vac @ 42 amps, will run a pair-\$30. Amp filament chokes 3-30mcs 30 amps \$9.50. Johnson 15 amp rotary ind. 27uh-\$25. HIGH POWER HEAD-QUARTERS IN THE NORTHEAST. COME IN AND SEE US — K1DQV.

*The Roger S. Miner*

**SURPLUS ELECTRONICS COMPANY**

246 NAUGATUCK AVENUE • MILFORD, CONNECTICUT 06460

**QSLs.** Second to none. Same day service. Samples 25¢. Ray, K7HLR, Box 331, Clearfield, Utah 84015.

**AMATEUR SALES & SERVICE.** Discount prices and service after the sale. Such leading names as Clegg, Kenwood, Pearce Simpson, Regency, SBE, Signal/One, and Tempo One. Write or call today. Amateur Sales and Service, 111 Rand Mill Road, Garner, North Carolina 27529. Tel. 1-919-772-6044.

**MARINE ELECTRONIC EQUIPMENT** — Make money in your spare time. Sell V.H.F., RADAR, and all types of marine gear. Send for details RAD-COM INC., Mamaroneck, New York 10543.

**JENNINGS VACUUM RELAY RE6B** — SPDT new in original box (new list over \$200.00) \$88.00 or trade for new 3-1000Z or what-have-you? Ed Kalin, WA1JZC/1, 410 Memorial Drive, Cambridge MA 02139.

**HAMFEST — WABASH COUNTY ARC** fourth annual hamfest, Sunday, May 21. Rain or shine. Admission is still only \$1. Flea-market, food, tech. talks and much more. For information write Bob Mitting, 663 Spring, Wabash, Indiana 46992.

**FREQUENCY ALLOCATIONS:** Complete Computer Printout of ALL Frequencies from 10 KHz to 90 GHz. \$1.00 each — CRD Associates, P. O. Box 291, Western Springs, Illinois 60558.

**TMC GPR-90/GSB-1 RECEIVER,** TMC FFR Receiver, FR-6/U Frequency Meter, FM Gear, 4-1000 A's, Regulated Power Supplies, much more. SASE for 4-page list. Richard Solomon, 19 Pierce Road, Watertown, Massachusetts 02172.

**THE PINE RIDGE** Amateur Radio Club of Chadron, Nebraska will hold their eighteenth annual Hamfest/Picnic at Chadron State Park located 9 miles south of Chadron on Hwy 385 Sunday, June 4, 1972. All amateurs and families welcome. Bring a covered dish and your own utensils. Soft drinks and coffee furnished. No admittance charge.

**ASK HARRY FIRST.** Good trades accepted. S.A.S.E. Name literature wanted. Harry's Amateur Radio Supply, 3528 Gaskin Rd. (Belgium) Baldwinville, NY 13027. 10AM-9PM. Closed Sunday. 315-635-7452.

**tone ENCODERS AND DECODERS** — New line of solid state encoders and decoders compatible with any sub-audible continuous tone system. Small in size, usable from 67-250 Hz, \$8.95 to \$14.95. Send for literature. Communications Specialists, Box 153, Brea, Calif. 92621.

**READOUT TUBES** — 7 Segment, 5 Volt Incandescent \$3.00. Polarizing filters. SASE complete list. Display Electronics, Box 1044, Littleton, Colo. 80120.

**HEWLETT PACKARD 400 DR,** works perfect, in calibration \$45. R. Galloway, 2220 Woodbury Rd., Eau Gallie, Florida 32935.

**CHOICE 7289 (3CX100A5)** Ceramic sub for 2C39A. Surplus. Prechecked at 449MC and guaranteed. \$5 ea, \$50 doc. postpaid. None better. No more when these gone. Ed Howell, W4SOD, Folly Beach, South Carolina 29439.

**BE PATIENT!** Only 170 days left before the gala opening of the Hudson Division Convention! Exhibits, Lectures, 2-meter FM, RTTY, Contests, Gabfests, New York Sightseeing, Fun. Free gift for each early registrant, Oct. 21-22. Hilton Motor Inn, Tarrytown, N. Y. Info from Dave Popkin, WA2CCF, 303 Tenafly Road, Englewood, N.J. 07631. Worth waiting for!

**SAVE MONEY** on parts and transmitting-receiving tubes. Foreign-Domestic. Send 25¢ for giant catalog. Refunded first order. United Radio Company, 56-HR Ferry Street, Newark, N.J. 07105.

**AUDIO FILTERS:** Knock down that background noise. KOJO SSB, AM and CW filters do the job. Write for free brochure and see how serious DX boys hear them. KOJO, Box 7774, 741 E. Highland Ave., Phoenix, Arizona 85011.

# CURTIS KEYERS

Contest  
Operators  
Dream!

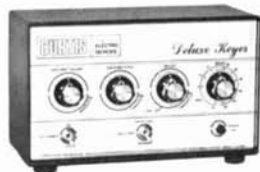

EK-404  
Deluxe Keyer ..... \$124.95

EK-402  
Programmable Keyer \$289.00

NOW AVAILABLE from  
**ELECTRONIC DISTRIBUTORS, Inc.**

— OUR 34th YEAR —  
1960 PECK STREET  
MUSKEGON, MICHIGAN 49441  
Ph: (616) 726-3196

## USED TEST EQUIPMENT

All checked and operating unless otherwise noted, FOB Monroe. Money back (less shipping) if not satisfied.

- GR650 - IMP. Bridge, direct RLC ..... 120
- Gertsch FM-7-Freq.-mtr.20-1000mHz .0001% 650
- GR1100AP - Freq. Standard, includes 1101A osc., 1102A multivib., 1103A Synchronometer and PS complete ..... 350
- HP150A - 10mHz Scope w/152B ..... 295
- HP160B(USM105)-14mHz dual trace scope 495
- HP175A - 50mHz scope w/dual trace, delayed sweep plug-ins ..... 795
- HP185B-DC-1gHz samp. scope w/186B ..... 625
- HP524D-Freq. counter 10hZ-10mHz ..... 325
- HP525A-10-100mHz plug-in for above ..... 65
- HP540-B-Trans. Osc. for counter-to 12gHz 385
- HP2590B-Precision Trans. osc-synchronizer 1165
- Kintel 301-DC standard-null voltmeter ..... 220
- Meas. 80 - Standard Sig. Gen. 2-400mHz ..... 225
- Meas 82-Stand sig.gen. 20hZ-50mHz ..... 275
- NE 14-20C-Freq.counter (sim. HP524C) ..... 209
- NE 14-21C-10-100mHz plug-in for above ..... 65
- NE 14-22C-100-220mHz plug-in for above ..... 80
- NLS M-24-Digital Volt-ratio-ohmmeter ..... 585
- NLS V-35 - Digital Voltmeter complete ..... 385
- Polarad R-microwave rcvr (plug-ins avail) 285
- Polarad TSA-spectrum analyzer 10mHz-44gHz (plug-ins available) ..... 325
- Polarad SA84W-spectrum analyzer, band switching 10mHz-41gHz ..... 1260
- Rollin 30-Stand.sig.gen.40-400mHz-hi-pwr. .... 585
- Tek B - 30mMz Hi-gain plug-in ..... 40
- Tek RM15-DC-15mHz GP scope ..... 325
- ME26D/U-(HP410B) VTVM-to 700mHz ..... 85
- TS-403A-Sig. Gen. (HP616) 1.8-4gHz ..... 385
- USM-16-Stand. Sig. Gen.10-440mHz AM-CW-FM-Pulse-Sweep, Phase-locked osc. .... 675

(Send SASE for complete list)

**GRAY Electronics**  
P. O. Box 941 Monroe, MI 48161  
Specializing in used test equipment

# G&G MILITARY ELECTRONIC SURPLUS

**BC-645 TRANSCEIVER** 15 tubes, 435 to 500 Mc.  
Easily adapted for 2 way voice or code on Ham, Mobile, Television Experimental, and Citizens Bands. With tubes, less power supply in factory carton, **BRAND NEW**..... **\$16.95**

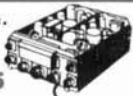

TRANSMITTER has 4 tubes: WE-316A, 2-6F6, 7F7  
RECEIVER has 11 tubes: 2-955, 4-7HP, 2-7E6, 3-7F7  
RECEIVER I.F.: 40 Megacycles  
SIZE: 10-1/2" x 13-1/2" x 4-1/2". Shpg wt 25 lbs.

SPECIAL PACKAGE OFFER: BC-645 Transceiver, Dynamator and all accessories, including mounting, UHF Antenna Assemblies, control box, complete set of connectors and plugs. **BRAND NEW**..... **\$26.95**

## 2" DC VOLTMETER

Mounts in 2-1/8" hole. Flange diameter 2-5/8"  
Two scales: 0-15 and 0-600. Calibrated for use on steel panel. Standard brand. **SPECIAL NEW**, boxed..... Each \$1.75 2 for \$3.00



**HEADSET** Low impedance. With large chamois ear cushions. 4-ft cord and plug. Reg. \$12.50. Our Special Price **\$2.95**  
Less ear cushions..... \$1.95  
High impedance adaptor for above... \$ .69



## SCR-274-N, ARC-5 COMMAND SET HQ!

Freq. Range RECEIVERS.	Type Complete with Tubes	Exc. Used	Like New	BRAND NEW
190 - 550 Kc	BC-453	\$16.95	\$23.50	\$27.50
6 - 9.1 Mc	BC-455	---	---	\$22.50
1.5 - 3 Mc	R-25	---	\$19.50	\$21.50
TRANSMITTERS.				
4 - 5.3 Mc	BC-457	\$8.95	---	\$11.95
5.3 - 7 Mc	BC-458	\$8.95	---	\$11.95

**TG-34A CODE KEYS**, self-contained, automatic, reproduces code practice signals from paper tape. 5 to 12 WPM Built-in speaker. Brand new with tech manual, takeup reel and AC line cord. **\$24.50**  
Code practice tapes for above P.U.R.



**BC-1206-C RECEIVER** Aircraft Beacon Receiver 200 to 400 Kc. Operates from 24V DC 1.5A. Continuous tuning, vol control, on-off switch and phone jack. Very sensitive. Compact. Complete with tubes, **NEW**..... **\$12.50**



**TG-10 CODE PRACTICE SET**  
Fine for schools or groups. Operates from 110V 60 Hz using inked paper tapes. Produces audible Morse code. 5 to 25 Words per Minute. 10 Watt amplifier. Excellent Used.. **\$14.95**



**DUAL AMPLIFIER** has two input circuits each feeding a single 6SN7GT twin triode amplifier. Complete with 115V 60 cy. power supply using 6X5GT rectifier. **NEW**..... **\$5.95**



**BC-603 FM RECEIVER**  
Converted for 35-50 Mhz. 10 preset pushbutton channels or manual tuning. Complete with 10 tubes, checked out, like new **\$39.50**  
AC Power Supply, New..... \$14.95  
DM-34 12V Power Supply, New..... \$ 4.45  
DM-36 24V Power Supply, Exc. Used... \$ 2.25  
Technical Manual ..... \$ 2.50  
Set of 10 tubes for BC-603 Receiver.. \$ 5.95



**BC-604 FM TRANSMITTER** 20 to 27.9 Mc. Output approx 30 watts, 10 crystal controlled channels. Complete with tubes. **NEW**..... **\$12.50**



ARC-R11A Modern Q-5 Receiver 190 - 550 KHz..... **\$10.95**  
ARC-R22 540 - 1600 KHz Receiver with tuning graph..... **\$15.95**  
R-4/ARR-2 Receiver 234-258 Mhz, 11 tubes, **NEW**..... **\$8.95**

BC-605 INTERPHONE AMPLIFIER, NEW \$3.45 EXC. USED... \$1.95  
TELEPHONE HANDSET, W.E. type..... LIKE NEW \$2.95  
SCR-522 TRANSMITTER-RECEIVER, with 18 tubes, LIKE NEW \$32.50

**TG-5B TELEGRAPH SET** for code communications or code practice. Portable, with hinged lid. Two or more units operate up to 25 miles apart. Bell call system, 1000 cycle howler, key, headpiece, canvas case, book. Size 5-1/2x5-1/2x10". **NEW**..... **\$8.95**



**ARC-5 VHF RECEIVER, TRANSMITTER, MODULATOR** 100-156 Mhz  
R-28 RECEIVER with tubes and crystal, Excellent Used..... **\$19.50**  
T-23 TRANSMITTER with tubes and crystals. Brand New in Original Carton... **\$23.50**  
MD-7 MODULATOR with tubes, Excellent Used ..... **\$10.50**  
Set of Plugs for MD-7..... \$ 8.50

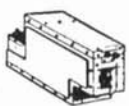

**BC-659 FM TRANSMITTER/RECEIVER**  
27 to 38.9 Mhz. Crystal control on any two preset channels: 80 channels. Uses FT-243 crystal. Range up to 5 miles. Complete with 13 tubes, speaker and meter. Like New ..... **\$27.50**  
Vibrator power supply for above, 6, 12 or 24 volts (specify) Like New..... \$ 8.95



**AN/ART-13 TRANSMITTER**  
Makes fine Ham transmitter for 80, 40, 20 and 10 meters. Power output 100 watts on AM, CW, MCW. 10 preset channels, Complete with all tubes, crystal. Exc. Used...\$49.50 **LIKE NEW. \$59.50**  
Accessories Available: Prices Upon Request



**TV-10 UHF TRANSVERTER** 28V DC  
Made by Aircraft Radio Corp. Couples UHF Antenna to VHF transmitter and VHF receiver. Uses 6 tubes: 4/5763 and 2/6201. Includes 8 crystals ranging from 233.8 Mc to 257.8 Mc. Size: 11x 4-1/2x4-5/8". Wt 5-1/2 lbs. **LIKE NEW**, with tubes and crystals..... **\$9.95**



**R-20 RECEIVER**  
Made by Aircraft Radio Corp, works on 28 V, includes 4 tubes: 2/12AV6, 12AX7, 12AT7. Size: 6-1/2x4-1/2x4-5/8". **LIKE NEW**..... **\$7.50**



**HANDMIKE**  
Rugged, heavy-duty carbon hand mike with press-to-talk switch. Equipped with 4-ft cord & phone plug. **NEW**, boxed..... Each **\$1.88** **SPECIAL 2 for \$3.25**



**LM FREQUENCY METER**  
Fine general purpose Navy unit 125 to 20,000 Hz. Operates on 12 or 24 VDC. Complete with tubes, crystal, calibration book. Checked out, Excellent Used .... **\$59.50**  
As above, less book ..... \$22.50



**BC-221 FREQUENCY METER**  
Accurate, reliable, crystal-calibrated, 125 to 20,000 Hz range. Useful as signal generator or VFO. Complete with tubes, Calibration book, checked out, Exc. Used... **\$59.50**  
1000 Hz Crystal for above..... \$5.50



**BC-223AX TRANSMITTER** 25 Watt, CW, MCW, Voice, Crystal control on 4 pre-selected channels, range 2000 to 5200 Kc by use of 3 plug-in units, included. Complete. **BRAND NEW**..... **\$22.50**  
Accessories available. Prices upon request.



**APN-1 FM TRANSMITTER** 400-450 Mc. Freq. modulated by moving coil transducer. Easily converted for radio control or 70 cms. Complete with 14 tubes, dyn. **BRAND NEW**..... **\$9.95**



**BB-208/AMT BATTERY PACK** contains three B852 36V miniature lead acid type storage batteries and one B851 6V battery..... **\$1.49**

**PE-219 BATTERY CHARGER** charges one or two 6V batteries at 7 amps from 6/12 or 24V source. **NEW**..... **\$5.95**  
**FL-30 Filter** with PL-55 plug and JK-26 Jack, Exc. Used... **\$1.59**

**WILLARD 2-VOLT STORAGE BATTERY**  
Rated at 20 Amp.-Hours. Model 20-2. Rechargeable. Compact nonspill construction. Lightweight polystyrene container, 3x4x5 1/2". Shipped dry, uses standard electrolyte. Shipping Weight 3 lbs. **NEW**, each..... **\$2.79**



TERMS: F.O.B. NYC. 25% deposit with order, balance COD or remittance in full. MINIMUM ORDER \$5.00. Subject to prior sale and price change

**G&G RADIO ELECTRONICS COMPANY**  
45-47 Warren St. (2nd Fl.) New York, N.Y. 10007 Ph. 212-267-4605



**"DON AND BOB" GUARANTEED BUYS.** Motorola HEP170 epoxy diode 2.5A/1000PIV .39¢; MOT MC1709CC OP AMP (709) .50¢; CAP: Sangamo DCM600MFD/450V 4.95; Computer grade 10000 MFD/15V 1.95; vacuum 50PF/7.5KV 1.95; Ham-M 99.00; TR44 59.95; AR22R 31.95; CDE rotor parts stock; Mosley CL33 114.00; CL36 134.00; Hy-Gain TH6DX 139.00; 400 rotor 148.00; Gladding 25 AC 2MFM 255.00; SBE144 2M10W (reg. 240.00) 199.95; Tri-Ex MW50 tower 229.00; 1 core 2408T coil 5.00; Ray 6LQ6 3.50; 6.3V/600MA transformer 1.95; #14 antenna wire 1.95/C; KY65 code identifier 5.95; guaranteed used gear: Collins 75A4 (clean) 395.00; SX115 250.00; Galaxy V 250.00; Tempo Kenwood dealer. Prices collect. Write quote note. Warranty guaranteed. Madison Electronics, 1508 McKinney, Houston, Texas 77002. (713) 224-2668.

**FREE CODE & THEORY CLASSES** every Wednesday night 8 p.m. at Land of Electronics, 400 South Main Street, Lombard, Illinois 60148. Call Phil, K9DTB (Mgr.) for info at (312) 495-1234 or 495-1982.

**SWAN 600-T 600-R** if you're using them at your QTH I'd like to know how they're performing. WA5NTI/O, 4321 Ozarkglen Drive, St. Louis, Mo. 63128.

**2W. AUDIO AMPLIFIER I.C.** short-proof ideal for monitors, intercomms, headphone applications, etc. Module \$4.75, I.C. \$2.85. Low noise dual preamp I.C. \$3.95. 5V/1A regulator I.C. \$2.95. Digital Clock/Counter power supply \$12.95. Phone Patch module \$21.95. Hundreds of I.C.'s and modules in Giant Catalog and Applications Guide. 25¢. Modevco Enterprises, Dept. 11S, P. O. Box 40073, Indianapolis, Indiana 46260.

**DRAKE 1-A rcvr \$75.00.** Eico 723 xmtr with SWR meter \$25.00. I will pay shipping insured/parcel post. R. O. Crosmer, 2131 W. Palmyra, Apt. B, Orange, CA 92668.

**YAESU FTdx 560** with speaker and CW filter \$400. Electrovoice 619 microphone \$20. Heathkit SB-610 monitor scope \$45. Heathkit HD-10 keyer \$30. Hustler 4BTV vertical \$25. All perfect. Doug Henry, WA7OHD/6, 292 N. Main St., Orange, CA 92668.

**TECH MANUALS** — \$6.50 each: R-388/URR, R-389/URR, R-390/URR, R-390A/URR, R-220/URR, URM-25D, SPA600JX-17, R-274/FRR. Hundreds more. Send 25¢ (coin) for 20-page list. W3IHD, 4905 Roanne Drive, Washington, DC 20021.

**COPY MORSE CODE** automatically, (Ham Radio November 1971) detailed construction plans \$14.95. VMG Electronics, 2138 West Sunnyside, Phoenix, Arizona 85029.

**MUST SELL** — TR3 — Excellent. Will accept reasonable offer. J. Henrichsen, K0K0Y, 431 Frank Avenue SE, Huron, S. D. 57350. 605-352-9267.

**FOR SALE:** Hammarlund HQ-170A, \$260, Heath DX-60B, \$65, HG-10B VFO, \$34, excellent cond., WA9ZRQ, 3800 Estes, Lincolnwood, Ill., 674-3732. Jeff Lerner.

**COLLINS:** Service - Sales - Trades. The house that treats you like a V.I.P. W1GEY, 321 Eastfield Dr., Fairfield, Conn. 06430. 203-374-8117.

**MACHINES:** Kleinschmidt TT-100 printer (60 & 100 gears incl.), TT-117 & 179 set, TT-109 punch, M14 reperf's, TDS, checked. Mark/space systems. 3563 Conquista, Long Beach, Cal. 90808. 213-429-5821.

**IRISH GUESTHOUSE** holiday exchanged for your unwanted VHF, mobile, sideband gear. Plenty of leisure activities, sightseeing and fishing opportunities locally and throughout southern areas. Contact Des Walsh, EI5CD, Ballylynch Carrick-on-Suir, Ireland.

**YOUR AD belongs here too.** Commercial ads 25¢ per word. Non-commercial ads 10¢ per word. Commercial advertisers write for special discounts for standing ads not changed each month.

# KW

**ELECTRONICS  
LIMITED**

A complete line of world famous British equipment Transceivers; separates, and auxiliaries: 160-10M

**KW ELECTRONICS**

10 Peru St., Plattsburg, N.Y. 12901

## NOW in the USA

### AT LAST! NO BAFFLING GAIN CLAIM GAME

IT WOULD BE EASY TO CLAIM 15db GAIN FOR OUR VERTICAL.....WE'D JUST USE WET STRING AS OUR REFERENCE! BUT WE DON'T! WE JUST USE A STANDARD DIPOLE. AND WE DELIVER AN HONEST 6db GAIN WITH THE

### AN-TEK AT-2FM

THE AT-2FM IS ONE OF THE MOST RUGGED VERTICAL 2 METER GAIN OMNIDIRECTIONAL ANTENNAS IN AMERICA.

WE PROVIDE MAIL ORDER SALES AND DEALERSHIPS IN THE ELEVEN WESTERN STATES THROUGH

**CLAJON ENTERPRISES**

1741 E. HELMICK ST., CARSON, CALIFORNIA, 90746

## SPECIAL 2 METER FM GLADDING 25™

AND  
AC POWER SUPPLY

**Special Package Deal  
Only \$275.00 May only**

**BOB'S DISCOUNT ELECTRONICS**

720 N. HUDSON, OKLAHOMA CITY, OK 73102  
405-232-1384

## 160 thru 40 METER ANTENNA TUNER



**\$44.95**  
PPD

MODEL 64MV MATCHVERTER WILL RESONATE PRACTICALLY ANY DIPOLE, BEAM, OR QUAD OVER ENTIRE 1.8-8.0 MHZ SPEC-TRUM.

- Handles 400W. PEP or 200W. DC
- Use coax or open feed-line
- Use with any SWR bridge
- Use with tri-band beams or quads
- Small in size — Made in USA

**TOP BAND SYSTEMS**

P. O. Box 15015, Long Beach, Calif. 90815

the Magnificent **CX7A** by  **signal/one**

**Features:**

1. All modes 10 through 160 meters in full 1 MHZ ranges.
2. Broad band tuning. Instant band changes without tuning.
3. True break-in CW with T/R switching.
4. IF shift — a real QRM slicer.
5. Pre IF noise blanker that really works.
6. RF envelope clipping sounds like a KW.
7. Transceiver — Plus — Receiver built-in two VFO's.



Phone or write

**DON PAYNE K4ID**

for a brochure and  
a big trade-in on  
your gear

**PAYNE RADIO**

Box 525

Springfield, Tenn. 37172

Days  
(615) 384-5573

Nites - Sundays  
(615) 384-5643

8. Calibration within 100HZ on frequency meter nixie digital counter.
9. 300 watt p.e.p. continuous duty cycle.
10. Built-in: FSK shift, spotter level, watt meter, SWR meter, transmit offset, CW electronic Keyer.
11. Quality-Plus. American-made. Hand-picked instrument grade components.
12. New unequalled reliability. "Ham" tested by hams.
13. Perfection **\$2195.00**

**CHEAPER than in 1947**

**R11A**, 190 to 550 KC receiver. Internally complete, with 6 tubes; 3 85 KC ifs, latest Hi-Q type, with ceramic coil form & base, adjustable coupling. See Sept. 1963 issue of 73, for conversion "Q-5er Reborn". As removed from aircraft, somewhat soiled and dented. **NO GUARANTEE**. Quantity prices on request. 10 lbs. each **\$5.00**

Schematic, wiring diagram with parts identification lists ea. 50¢; w/purchase of R11A 30¢ **DMX-310**, 24v. DC dynamotor, for R11A, w/base (D10A), ex. used. 2 lbs. \$3.00; w/R11A **\$2.50** Sorry, no other accessories, control box, plugs, etc. available.

**RT67A/ARC-3** .96 to 156 MC, AM, 8 channel, crystal controlled transmitter. As removed from aircraft, somewhat soiled and dented; internally complete with all tubes, including (2) 832. See surplus Conversion Manuals. **NO GUARANTEE**. 24 lbs. No accessories. ea. **\$20.00**

Above may be ordered from Pacer Engineering or BC. All below from BC only.

**RT82/APX-6**, 700 to 1400 MC, transponder (IFF). Very excel. used. Internally complete, with 3 cavities, 1B40, 2C42 & 2C46 cavity tubes, **LESS** all other tubes. 40 lbs. **\$8.50**

**MD-7/ARC-5**, plate modulator for all ARC-5, command transmitters. Very excel. used, internally complete with all tubes. 12 lbs. each **\$7.50**

**DB meter**, 2 1/2" rd. RUGGEDIZED, by PHAOSTRON. 199 ua DC, 660 ohm, internal resistance. Scale, white figures, black background, -20 to +3 DB. **BRAND NEW**. 4/\$11. ea. **\$3.00**

All prices are NET, FOB, location, as indicated. All items subject to prior sale. **PLEASE** — include sufficient for postage. Any excess remittance, returned with order. Insufficient postage too **COSTLY** — **SELDOM REPAID**. Illinois residents, add 5% for "sales tax".

**BC ELECTRONICS — c/o BEN COHN**  
MAILING ADDRESS

1249 W. Rosedale Ave., Chicago, Illinois 60660  
Store address: 5696 N. Ridge Ave., Chicago, Ill. 60660. Hours: Wed. 11 a.m. to 2:30 p.m.; Sat. 10:00 a.m. to 2:30 p.m. Other times by appointment. 312-784-4426 & 334-4463

**PACER ENGINEERING, INC.**

13911 Lincoln Ave., Dolton, Illinois 60419  
312-841-6663

**SEMICONDUCTOR BARGAINS**

SIGNETICS • NATIONAL  
RAYTHEON



— SATISFACTION GUARANTEED —

DIGITAL TTL			
7400N	30¢	7440N	30¢
7401N	30¢	7441AN	\$1.60
7402N	30¢	7442N	\$1.50
7403N	30¢	7447N	\$1.79
7404N	30¢	7451N	30¢
7410N	30¢	7454N	30¢
7420N	30¢	7472N	50¢
7430N	30¢	7473N	60¢
		7474N	60¢
		7475N	\$1.25
		7476N	65¢
		7490N	\$1.25
		7492N	\$1.25
		7493N	\$1.25
		7495N	\$1.50
		74107N	65¢
		74121N	75¢

LINEAR INTEGRATED CIRCUITS

DIP or TO-5 709 50¢ 10/\$4.50, 741 62¢ 10/\$5.75  
723C TO-5 \$1.35 NE565A PLL DIP \$6.00

GENERAL PURPOSE TRANSISTORS

2N5134 Si NPN or 2N5138 Si PNP 15¢ 8/\$1.00

1 AMP SILICON SUBMINIATURE RECTIFIERS

1N4001 50 PIV, 1N4002 100 PIV, 1N4004 200 PIV  
1N4005 600 PIV 10/\$1.00, 100/\$7.50

Free catalog — Large quantity discounts — Orders less than \$10. add 25¢ — others postpaid.

**DIGI-KEY, Box 126A, Thief River Falls, MN 56701**

 **signal/one CX7-A**



NEW ALPHA 70 — NOW BY CMI • NEW 8877 FINAL • THE LINEAR FOR THE CX7-A.

YOU WILL NEVER KNOW HOW LITTLE IT COSTS TO OWN THE INCOMPARABLE PRESTIGE CX7-A OR ALPHA 70 UNTIL YOU WRITE OR PHONE US THE TRADE IN DEAL YOU WANT • WE USUALLY SAY YES! NO ONE ANYWHERE BEATS OUR DEAL!

**AMATEUR-WHOLESALE ELECTRONICS**

8817 S.W. 129 Terrace • Miami, FL 33156  
Days (305) 233-3631 • Nights-Weekends (305) 661-7576

**Just Printed !**

Application Rules FOR  
TTL INTEGRATED CIRCUITS  
INCLUDING **Operating**  
Instructions FOR ALL  
POPULAR MODELS

send 50¢  
for your copy  
FREE WITH ANY ORDER  
OVER \$5.00



MINITRON 7-SEGMENT  
READOUT \$3.70

Digital Clock  
Semi-kit

15 IC'S & 4 MINITRONS (ONLY)  
120 VAC \$35.00

SEND 25¢ FOR CATALOG



Arizona Semiconductor

PO BOX 112  
GOODYEAR, ARIZONA  
85338

**TYMETER**  
"Time At A Glance"  
DIGITAL CLOCKS



**24**  
**HOUR**  
**CLOCK**



#100-24H

**\$16**

Made in  
U.S.A.

Walnut or ebony plastic case.  
4" H, 7 3/4" W, 4" D. 110V 60  
cy. Guaranteed One Year.

At Your Dealer, or  
DIRECT FROM

**PENNWOOD NUMECHRON CO.**

TYMETER ELECTRONICS

7249 FRANKSTOWN AVE. PITTSBURGH, PA. 15208

**SB-36 TRANSCEIVER**

by SBE

Write for our low, low introductory price.

**NO ONE ANYWHERE BEATS OUR DEAL**

**AMATEUR-WHOLESALE ELECTRONICS**

8817 S.W. 129 Terrace, Miami, FL 33156 305-233-3631

... COMPLETE YOUR HAM SHACK with  
OUR NEW HOME WEATHER INSTRUMENT:

• READ WIND SPEEDS ON TWO  
SCALES; CALIBRATION to 106 mph

• HANDSOME HARDWOOD CASE

• 2 YEAR WRITTEN GUARANTEE

• ELECTRONICS EMPLOYS  
INTEGRATED CIRCUITS

• **5%** DISCOUNT TO ALL HAM'S  
ACTIVE IN WEATHER NETS

• Includes Display Unit and Rotor  
mechanism (both shown), 60 ft.  
lead in, mounting hardware,  
battery, instruction manual



\$59.95 COMPLETE  
POSTAGE PAID  
(dealer inquiries invited)

**associates**, BOX 333, GOODYEAR, AZ. 85338

# RADIO CONSTRUCTOR COVERS IT ALL. THE WHOLE SPECTRUM

Audio Construction Projects  
Receiver Construction Projects  
Test Equipment Projects  
Radio Control Projects  
Transmitter Construction  
Projects

... and much more.



Try a subscription today

\$7.00 per year

write

**RADIO CONSTRUCTOR**  
GREENVILLE, N. H. 03048

NAME .....

ADDRESS .....

CITY .....

STATE .....

ZIP .....

# bug killer

# electric

The non-poisonous answer to insect & mosquito problems

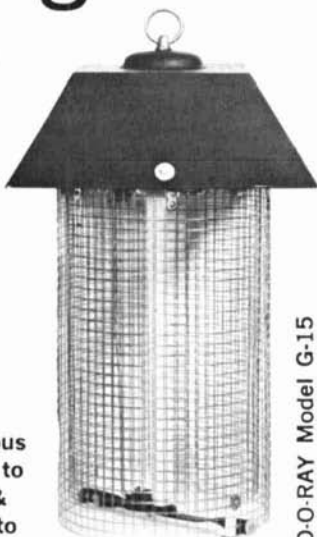

RID-O-RAY Model G-15

Enjoy those warm Spring and Summer evenings in bug free peace. Attracted by a "black light" as many as 5000 bugs every minute are incinerated by an electrically charged element.

Virtually maintenance free, the Rid-O-Ray is weather proof and harmless to birds and animals. Just hang up and plug in. A model for every sized job. Model G-15 controls 1/4 acre, Model D-15 controls 3/4 acre.

## comtec

GREENVILLE, NH 03048

Please Send

Model G-15 Rid-O-Ray Only \$79.95

Model D-15 Rid-O-Ray Only 99.95

Shipping paid in 48 states

Enclosed is check or money order.

Please charge

Mastercharge No. ....

Bank No. ....

BankAmericard No. ....

Expiration Date .....

Name .....

Address .....

Town .....

State ..... Zip .....

## MAY WINNERS

IN

### TRI RIO'S

#### 6th ANNIVERSARY CELEBRATION

KENNETH P. BILLINGS, W9FK1/4

ST. PETERSBURG, FLORIDA

A SIGNAL INJECTOR

ACE COMMUNICATIONS

LA CROSSE, WISCONSIN

A BROADCAST STUDIO LINE AMPLIFIER

(See our ad in February HR)

## DTL LOGIC CARDS

5 CARDS! 5 USEABLE CIRCUITS! ONLY \$1.00

PLUS \$0.25 POSTAGE

\$0.50 FOREIGN

OVER 100 COMPONENTS. DIODES, TRANSISTORS, RESISTORS, AND CAPACITORS. COMPLETE WITH CIRCUIT DIAGRAMS FOR EACH CARD. NAND GATES, FLIP FLOPS, LINE DRIVERS, ETC. EACH CARD A CIRCUIT BY ITSELF!

## PLUS

5 CIRCUIT DIAGRAMS OF DEVICES YOU CAN BUILD USING THESE CARDS. CPO, AUDIO OSCILLATOR, TACHOMETER, CRYSTAL CALIBRATOR, NOVICE RECEIVER, DIRECT COUPLED ONE WATT AMPLIFIER, AND MORE!

## PLUS

A CONTEST!

FOR THE TWO BEST CIRCUITS SENT TO US EACH MONTH, DERIVED FROM THESE CARDS, WE WILL GIVE TWO FREE ONE YEAR SUBSCRIPTIONS TO HAM RADIO MAGAZINE. ALL WINNERS NAMES TO BE PUBLISHED!

## PLUS

THESE CARDS ARE JUST PLAIN GREAT FOR SCHOOLS, NOVICES, AND ANY SERIOUS EXPERIMENTER, WHO CARES TO STUDY TRANSISTOR CIRCUITS. GREAT FOR BREADBOARDING PROTOTYPE IC CIRCUITS. IF YOU MAKE A MISTAKE IT CAN BE CORRECTED!

## COPPER CLAD LAMINATES

G10 EPOXY GLASS

1 oz. Copper 1 Side

Pkg. Quant.	3/64"	1/16"	3/32"	1/8"
1 9x12"	\$1.50	\$2.50	\$3.50	\$5.00
2 6x9"	"	"	"	"
4 4 1/2 x 6"	"	"	"	"
6 3 x 4 1/2"	"	"	"	"

This item postage prepaid.

Every order unconditionally guaranteed.

## TRI RIO

2614 Lake Shore Dr. *Electronics* LaCrosse, 2, Wis. 54601

Wisconsin Residents add 4% Sales Tax.

# FM

means Far More value and variety at **SPECTRONICS** because we are

**THE**

# FM

**PEOPLE**

If you don't see what you want **ASK.**

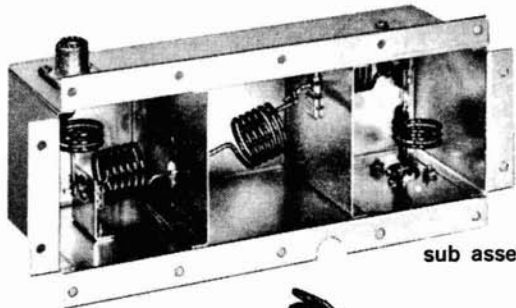

sub assemblies



parts

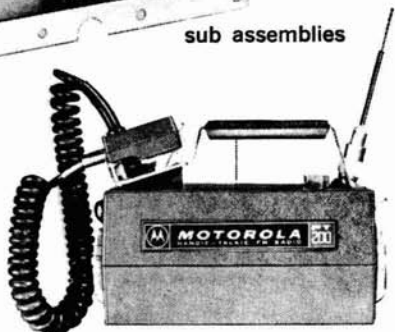

portables

hand holds



test equipment



base units and remotes

mobiles



More gear in one place than you've ever seen before.

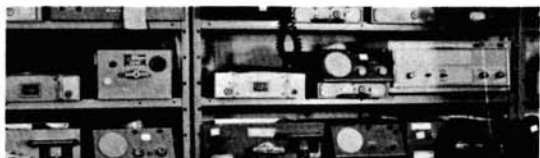

# SPECTRONICS

1009 GARFIELD AVENUE  
OAK PARK, ILL. 60304

312-848-6778

**BRAND NEW FREQ-SHIFT TTY MONITOR**  
 NAVY OCT-3: FM Receiver type, freq. range 1 to 26 MHz in 4 bands, cont. tuning. Crystal calib. Reads up to 1500 Hz deviation on built-in VTVM. Cost \$1100.00 each! In original box, with instruct. book & cord, fob Mariposa, Cal. Shpg. wt. 110 lbs. 49.50.

**HIGH-SENSITIVITY WIDE-BAND RECEIVER**

COMMUNICATIONS • BUG DETECTION  
 • SPECTRUM STUDIES

38-1000 MHz AN/ALR-5: Consists of brand new tuner/converter CV-253/ALR in original factory pack and an exc. used, checked OK & grid main receiver R-444 modified for 120 v. 50/60 Hz. The tuner covers the range in 4 bands: each band has its own Type N Ant. input. Packed with each tuner is the factory inspector's checkout sheet. The one we opened showed SENSITIVITY: 1.1 uv at 38.4 mhz, 0.9 at 133 mhz, 5 at 538 mhz, 4 1/2 at 778 mhz, 7 at 1 ghz. The receiver is actually a 30 mhz IF ampli. with all that follows, including a diode meter for relative signal strengths: an atten. calibrated in 6 db steps to -74 db, followed by an AVC position; Pan., Video & AF outputs; switch select pass of  $\pm 200$  kHz or  $\pm 2$  mhz; and SELECT AM or FM! With Handbook & pwr. input plug, all only 375.00

We have SP-600-JX, R390, WRR-2 Receivers. Ask!

**REG. PWR. SPLY FOR COMMAND, LM, ETC.**

PP-106/U: Metered. Knob-adjustable 90-270 v up to 80 ma dc; also select an AC of 6.3 v 5A, or 12.6 v 2 1/2 A or 28 v 2 1/2 A. With mating output plug & all tech. cata. Shpg. wt. 50 lbs. 19.50

**BARGAINS WHICH THE ABOVE WILL POWER:**

LM-(1/2) Freq. Meter: 125-20 MHz, .01%, CW or AM, with serial-matched calib. book, tech. data, mating plug. Shipping wt. 16 lbs. 57.50  
 TS-323 Freq. Meter: 20-480 MHz .001% 169.50  
 R22A/ARC5 Command Q-5er 190-550 kHz, exc. cond. 16.95  
 A.R.C. R22 Command rcvr 540-1600 KHz, exc. cond. 17.95  
 A.R.C. R15(MIL R-509)Command. 108-135 MHz, new 27.50

NEMS-CLARKE #1670 FM Rcvr 55-260 MHz like new 475.00  
 WWV Rcvr/Comparator 2 1/2" 20 MHz 195.00  
 Empire Devices NF-114 RFI meter is a red-hot receiver from 150 KHz to 80 MHz 295.00

Attention Buyers, Engineers, Advanced Technicians: We have the best test-equipment & oscilloscope inventory in the country so ask for your needs . . . don't ask for an overall catalog . . . we also buy, so tell us what you have.

**R. E. GOODHEART CO. INC.**  
 Box 1220-HR, Beverly Hills, Calif. 90213  
 Phone: Area Code 213, Office 272-5707

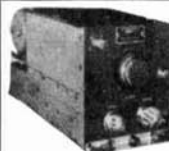

ARC R-19 (R-508) Receiver 118-148 MHz tunable. 9 tube Superheterodyne AM Receiver. If 15 MHz checked out with schematic, \$14.95. Blower 115 VAC 60 CPS 1PH. 20 CFM 3400 RPM, \$4.95. Teletype Tape 3/8 canary, 10 rolls \$1.25. New catalogue now available 10¢

FRANK ELECTRONICS  
 407 Ritter Road, Harrisburg, Pa. 17109

**WE PAY HIGHEST PRICES FOR ELECTRON TUBES AND SEMICONDUCTORS**

**H & L ASSOCIATES**

ELIZABETHPORT INDUSTRIAL PARK  
 ELIZABETH, NEW JERSEY 07206

(201) 351-4200

**SPACE ELECTRONICS division of MILITARY ELECTRONICS CORP. WANTS TO BUY**

All types of military electronic equipment and parts. Call collect for cash offer.

76 Brookside Drive, Upper Saddle River  
 New Jersey 07458 • (201) 327-7640

**INOUE 2 mtr FM**

12 chan. IC-20 mob. unit/10 crystals \$259.50  
 24 channel IC-21, built-in AC supply, RIT, DISC. mtr SWR ind. with 10 crystals \$339.50  
 Extra crystals for IC-2F, IC-20 and IC-21 \$2.50  
 90 day warranty

Send Cashier's Check or Postal M/O to:  
 Woody W7RC — RC ENGINEERING  
 15051 SE 128 St., Renton, Washington 98055

**FREE CATALOG**

**HARD-TO-FIND PRECISION TOOLS**

Lists more than 1700 items—pliers, tweezers, wire strippers, vacuum systems, relay tools, optical equipment, tool kits and cases. Also includes four pages of useful "Tool Tips" to aid in tool selection.



**JENSEN TOOLS and ALLOYS**  
 4117 N. 44th Street, Phoenix, Arizona 85018

**NEW GLASSING 25**

FM TRANSCEIVER, 25 WATTS OUTPUT, 6 channels complete with xtals for 146.34/146.76 and 146.94/146.94, low power position, completely separate xmit-rec xtal switching. Built in 12V DC supply. (Amateur net \$249.95) OUR LOW INTRODUCTORY PRICE \$212.50. With matching AC supply (reg. \$299.95) \$255.00. Write for literature. Ham-M's \$99.00.

**AMATEUR-WHOLESALE ELECTRONICS**

8817 S.W. 129 Terrace, Miami, FL 33156 305-233-3631

**ULTRA-BAL 2000**

- Advanced design
- No radiation from coax, more power to antenna
- Less noise on receive
- Full 2KW—3 to 30 Mcs., 1:1 or 1:4 ratios
- Encapsulated ultra weather proof
- Mini type 2KV Teflon insulation over silver plated wire for ultra low loss



Specify ratio desired \$ 8.95 ppd.

**K.E. Electronics**

Box 1279, Tustin Calif. 92680

**AT LAST!!**

An Inexpensive Connector for RG-17/U Coax

- Less than .1db loss at 500MHz
- Teflon insulation • Solderless
- Connects directly to standard SO239

\$9.95 each PPD or Write for full information

**WAYNE SMITH PRODUCTS**

P. O. Box 46521, Bedford, Ohio 44146



**SATURN SIX MOBILIZER**

S-2 6M Ant. only \$12.50  
 S-1 Ant, Mast & Mnt 17.75  
 3L 6M Hilltopper 14.95  
 8L 2M Hilltopper 16.95

Also 6&2 Lunenburg Beams, Halos, Hula-Hoop  
 HI-PAR PROD. Box 88 FITCH. MASS. 01420

**WB2TUH**

Dress up your shack. Show your Call Letters proudly in a new smart bold distinctive style. Die Cast Aluminum Letters with a satin silver anodized finish. Giant 3 1/2" size. Three dimensional effect. Easily mounted on Wood, Plastic, Metal. ~~Presently unavailable~~

**RACE & RALLY**

79 WASHINGTON STREET, BROOKLYN, N. Y. 11201

# How to Defend Yourself

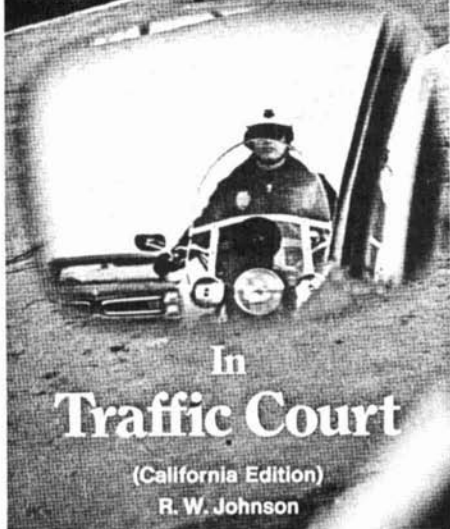

## In Traffic Court

(California Edition)

R. W. Johnson

If you've ever had to appear in California traffic court, you know how costly the process can become in terms of time, harassment, and money. Now you can increase the odds in your favor by reading and using this new book, "How to Defend Yourself in Traffic Court."

There are over 165 pages of authoritative information on handling your own traffic tickets and traffic cases — even ways to avoid a citation in the first place.

Printed, bound, illustrated, with a complete index, this new publication is based on the author's own 35 years first hand experience. Not recommended for use outside of California.

comtec

BOOKS

Greenville, New Hampshire 03048

Please send a copy of  
"How to Defend Yourself in Traffic Court"  
at \$3.65 postpaid

NAME .....

STREET .....

CITY ..... Zip .....

Check or Money Order  
Enclosed

Charge my Mastercharge  
Account No. ....

Charge my BankAmericard  
Account No. ....



## TV-7/U ELECTRON TUBE TESTER



PORTABLE DYNAMIC MUTUAL  
CONDUCTANCE TYPE

Used to test and measure the performance capabilities, and to determine the rejection limits for Electron Tubes used in Receivers, low power Transmitters, & in many other electronic equipment. The tests made are for dynamic mutual conductance, emission, shorts, gas, noise, continuity, pilot lamp, etc. Test sockets are for local, octal, 4.5.6, 7 pin, Norval 9, 7 pin miniature, sub-min. rd. & flat, acorn, etc. With special adapters (THAT ARE OPTIONAL) 829, 832, 2C39 and sub-min. tubes with long leads also can be tested. Power required: 115 Volt 50 to 1000 cycles. Tube test data charts, test leads and pin straighteners for 7 & 9 pin are included. Size: 6 1/2" x 8 1/2" x 1 1/2". Wt.: 20 lbs. PRICES: Used, serviceable \$19.95. Checked \$25.00. Adapter for 2C39 \$5.00 For 829/832 \$5.00 For sub-min. Lg. Lead \$3.00. All prices FOB Lima, Ohio.

Dept. HR — SEND FOR NEW CATALOG

FAIR RADIO SALES

P.O. Box 1105 · LIMA, OHIO · 45802

## WORLD QSL BUREAU

THE ONLY QSL BUREAU to handle all of your QSLs to anywhere; next door, the next state, the next country, the whole world. Just bundle them up (please arrange alphabetically) and send them to us with payment of 5¢ each.

5200 Panama Ave., Richmond, CA USA 94804

AMPEREX  
READOUT  
TUBE

170 volt neon  
Brand new  
\$3.00 ea.  
10/\$25.00



7 SEGMENT  
LO-VOLTAGE

GE #Y4075, 25V,  
readout. 1.6 inch  
hi. Wire leads.  
Brand new. \$3.00  
each or 10/\$25.



Giant Alpha-Numeric Neon Readout.

Complete alphabet plus all digits; 15 segments, 2 1/2" high. \$3.00 each, 10 for \$25.00. Sockets available at 50¢ each. Sockets available only for tube purchasers.

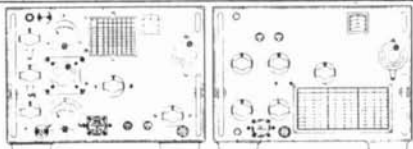

TCS — Collins Design: 1.5 thru 12 mcs, 4 channel crystal or tuneable, voice or CW. Receiver is fine for general short wave listening. Transmitter is excellent for the Ham, Novice, CD, etc. First class condition, with schematic and power supply info. \$40.00 each unit or \$75.00 the pair.

3 WATT LASER DIODE TA-2628 \$5.00  
PANADAPTER BC 1031 Used \$45  
Unused w/spares \$75  
56K MEMORY CORE STACK \$100  
LASER DISCHARGE CAP  
40 uf 3 KV 180 JOULES \$10  
COMPUTER GRADE CAPS 1000 uf 450V  
\$1.50 ea. 10/\$12  
MAN-3 LED READOUT \$3.50 ea. 10/\$35

Please add postage for above items.  
Send 25¢ for Surplus Catalog . . .

JOHN MESHNA JR. ELECTRONICS

P.O. Box 62 E. Lynn, Mass. 01904

# Advertisers check-off

... for literature, in a hurry —  
we'll rush your name to the companies  
whose names you "check-off"

## INDEX

- |                      |                   |                    |
|----------------------|-------------------|--------------------|
| —ATV                 | —Electronics      | —Pennwood          |
| —Alarm               | —Digest           | —Poly Paks         |
| —Alco                | —Electronic       | —Odyssey           |
| —Alpha               | —Distributors     | —RF                |
| —Amateur-Wholesale   | —Environmental    | —RP                |
| —American States     | —Products         | —Race and Rally    |
| —Amrad               | —Erickson         | —Radiation         |
| —Andy                | —Expo             | —Callbook          |
| —Antenna Mart        | —Fair             | —Radio             |
| —Apollo              | —Foreign Language | —Constructor       |
| —Arizona             | —Frank            | —Radio Shack       |
| —B C                 | —Gateway          | —Rejsa             |
| —Barker-Williamson   | —Gray             | —Rochester Hamfest |
| —Barry               | —Gregory          | —Ross & White      |
| —Bill's              | —H & L            | —SAROC             |
| —Bob's               | —HAL              | —Savoy             |
| —CNE                 | —Ham Radio        | —Signal/One        |
| —Camp Butler         | —Center           | —Sonar             |
| —Circuit-Specialists | —Heath            | —Space-Military    |
| —Cir-Kit             | —Heights          | —Spectronics       |
| —Clajon              | —Henry            | —Spectronics-FM    |
| —Coletronics         | —Hi-Par           | —Spectrum          |
| —Comcraft            | —Hy-Gain          | —Sprague           |
| —Computer Terminal   | —International    | —Standard          |
| —Comtec              | —Crystal          | —Jan Glass         |
| —Controlonics        | —Jan              | —Structural        |
| —Crawford            | —Janel            | —Swan              |
| —CTG-Bitcil          | —Jensen           | —Surplus           |
| —CU                  | —KE               | —Telrex            |
| —Cubex               | —KS               | —Top Band          |
| —Curtis              | —KW               | —Topeka            |
| —Cushcraft           | —Kirk             | —Tri-Ex            |
| —Data                | —L.A.             | —Tri-Rio           |
| —Digi-Key            | —Larsen           | —Triplet           |
| —Drake               | —Lee              | —Van's             |
| —Dycomm              | —Lee-Com          | —Vanguard          |
| —Eimac               | —Linear           | —Vector            |
| —Electronic Circuits | —Lynch            | —Smith             |
|                      | —Micro-Z          | —Weinschenker      |
|                      | —Mini-Products    | —Wolf              |
|                      | —Palomar          | —World QSL         |
|                      | —Payne            | —Xcelite           |
|                      | —Pearce-Simpson   |                    |

May 1972

Please use before June 30, 1972

Tear off and mail to  
**HAM RADIO MAGAZINE — "check-off"**  
Greenville, N. H. 03048

NAME.....  
CALL.....  
STREET.....  
CITY.....  
STATE.....ZIP.....

# Advertisers iNdex

ATV Research	110
Alarm Component Distributors	116
Amateur Electronic Supply	23, 41
Amateur-Wholesale Electronics	120, 121, 124
American States Electronics	106
Amrad Supply, Inc.	108
Andy Electronics	112
Antenna Mart	112
Arizona Semi-Conductor	121
BC Electronics	120
Barker-Williamson, Inc.	116
Barry	110
Bill's Radio	88
Bob's Discount Electronics	119
CNE Magazine	108
Camp Albert Butler	79
Circuit-Specialists Co.	94
Cir-Kit	90
Clajon Enterprises	119
Comcraft	11
Comtec	83, 122, 125
Crawford Electronics	104
CTG-Bitcil Systems, Inc.	81
CU Associates	121
Cubex Company	94
Curtis Electro Devices	110
Cushcraft	77
Data Engineering, Inc.	104, 108
Digi-Key	120
Drake Co., R. L.	90, 116
Dynamic Communications, Inc.	27
Eimac, Div. of Varian Assoc.	Cover IV
Electronics Digest	113
Electronic Distributors, Inc.	117
Environmental Products	111
Erickson Communications	105
Expo '72	125
Fair Radio Sales	112
Foreign Language QSO's	124
Frank Electronics	118
G&G Radio Supply Co.	106
Gateway Electronics	124
Goodheart Co., Inc., R. E.	117
Gray Electronics	109
Gregory Electronics	124
H & L Associates	75
HAL Communications Corp.	92
Ham Radio Center, Inc.	53
Heath Co.	89
Heights Manufacturing Co.	Cover III
Henry Radio Stores	124
Hi-Par Products Co.	64, 65, 102, 103
Hy-Gain Electronics Corp.	128
International Crystal Mfg. Co., Inc.	84
Jan Crystals	110
Janel Labs.	124
Jensen Tools and Alloys	124
KE Electronics	116
KS Industries	119
KW Electronics	31
Kirk Electronics	107, 127
L.A. Electronic Sales	104
Lee Electronics	86
Lynch Co., J.	125
Meshna, John, Jr.	90
Micro-Z Co.	85
Mini-Products Inc.	88
Palomar Engineers	120
Payne Radio	121
Pennwood Numechron Co.	114
Poly Paks	84
RP Electronics	124
Race and Rally Accessories	108
Radiation Devices Co.	49, 86
Radio Amateur Callbook	121
Radio Constructor	82, 106
Rochester Hamfest	92
SAROC	69
Savoy Electronics	Cover II
Signal/One Corporation	124
Space-Military Electronics	5
Spectronics, Inc.	123
Spectronics-FM	82
Spectrum International	1
Standard Communication Corp.	73
Structural Glass Limited	116
Surplus Electronics	98, 99
Swan Electronics Co.	92
Telrex Laboratories	119
Top Band Systems	2
Tri-Ex Tower Corp.	122
Tri-Rio Electronics	110
Van's, W2DLT	101
Vanguard Labs	94, 100, 101
Wayne Smith	124
Weinschenker, M.	87
Wolf, S.	112
World QSL Bureau	125



# BONUS THE BEST ANTENNA PACKAGES YET!

**OPTIMUM PERFORMANCE  
GUARANTEED SAVINGS**



ALL NEW, engineered for optimum performance with TRI-EX's Certified Antenna Towers & HY-GAIN's TOP Performance Antennas. The utmost in craftsmanship and construction for your satisfaction. . . .

Local Bank Financing - 15% Down or Trade-In Down - Good Reconditioned Equipment. Nearly all makes and models. Our reconditioned equipment carries a 30 day warranty and may be traded back within 90 days for full credit toward the purchase of NEW equipment. Inquiries invited.

\* Certified Welders & Approved by L.A. City

W51 SHOWN

LAE MW35 "STANDARD" Package  
(Free Standing Crank-Up Tower  
9.5 Sq. Ft. - 50 MPH) (35 Ft.)  
CDR AR-22R Rotator\*  
100 ft. RG-58/U Coax & Control Cable  
Substitute 50 ft. free standing, add \$100  
Complete with one of the following  
antennas:

HY-GAIN TH2MK3	\$259
HY-GAIN TH3JR	\$259
HY-GAIN DB10-15A	\$265
HY-GAIN HY QUAD	\$280
HY-GAIN TH3MK3	\$290
*TR-44 rotor w/cable add:	\$ 30
HAM-M rotor w/cable add:	\$ 60

LAE W51 "DELUXE" Package (51 Ft.)  
(Free Standing, 9 Sq. Ft. - 50 MPH)  
CDR TR-44 rotor\*

100 ft. RG58/U Coax & Control Cable  
Substitute 67 ft. free standing, add \$400  
Complete with one of the following  
antennas:

HY-GAIN DB10-15A	\$575
HY-GAIN HY QUAD	\$590
HY-GAIN 204BA	\$610
HY-GAIN TH3MK3	\$610
HY-GAIN TH6DXX	\$635

Free stdg. base incld. NO/CHARGE

\*HAM-M rotor w/RG8/U add: \$ 40

LAE LM354 "SUPER" Package (54 Ft.)  
(16 Sq. Ft. - 60 MPH)

CDR HAM-M Rotor  
100 ft. RG8/U Coax & Control Cable  
Substitute 70 ft. free standing, add \$650  
Complete with one of the following  
antennas:

HY-GAIN TH3MK3	\$735
HY-GAIN 204BA	\$740
HY-GAIN TH6DXX	\$765

Freight PREPAID to your door in the Continental USA west of the Rockies. For shipment east of the Rockies, add \$10.00. Substitutions may be made.... write for prices.

"WEST COAST'S FASTEST GROWING AMATEUR RADIO DISTRIBUTOR"  
"WE SELL ONLY THE BEST"



## Electronics Sales

23044 S. CRENSHAW BLVD., TORRANCE, CALIF. 90505

Phone: (213) 534-4456 or (213) 534-4402

HOME of LA AMATEUR RADIO SALES

# for the EXPERIMENTER!

**INTERNATIONAL EX CRYSTAL & EX KITS**  
 OSCILLATOR • RF MIXER • RF AMPLIFIER • POWER AMPLIFIER



### 1. MXX-1 TRANSISTOR RF MIXER

A single tuned circuit intended for signal conversion in the 3 to 170 MHz range. Harmonics of the OX oscillator are used for injection in the 60 to 170 MHz range. Lo Kit 3 to 20 MHz, Hi Kit 20 to 170 MHz (Specify when ordering).....\$3.50



### 2. SAX-1 TRANSISTOR RF AMP

A small signal amplifier to drive MXX-1 mixer. Single tuned input and link output. Lo Kit 3 to 20 MHz, Hi Kit 20 to 170 MHz (Specify when ordering).....\$3.50

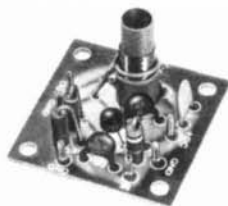

### 3. PAX-1 TRANSISTOR RF POWER AMP

A single tuned output amplifier designed to follow the OX oscillator. Outputs up to 200 mw, depending on the frequency and voltage. Amplifier can be amplitude modulated. Frequency 3,000 to 30,000 KHz.....\$3.75



### 4. BAX-1 BROADBAND AMP

General purpose unit which may be used as a tuned or untuned amplifier in RF and audio applications 20 Hz to 150 MHz. Provides 6 to 30 db gain. Ideal for SWL. Experimenter or Amateur .....\$3.75

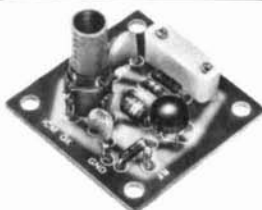

### 5. OX OSCILLATOR

Crystal controlled transistor type. Lo Kit 3,000 to 19,999 KHz, Hi Kit 20,000 to 60,000 KHz. (Specify when ordering).....\$2.95



### 6. TYPE EX CRYSTAL

Available from 3,000 to 60,000 KHz. Supplied only in HC 6/U holder. Calibration is  $\pm .02\%$  when operated in International OX circuit or its equivalent. (Specify frequency) .....\$3.95

## for the COMMERCIAL user...

### INTERNATIONAL PRECISION RADIO CRYSTALS

International Crystals are available from 70 KHz to 160 MHz in a wide variety of holders. Crystals for use in military equipment can be supplied to meet specifications MIL-C-3098E.

**CRYSTAL TYPES:** (GP) for "General Purpose" applications  
 (CS) for "Commercial Standard"  
 (HA) for "High Accuracy" close temperature tolerance requirements.



write for  
CATALOG



CRYSTAL MFG. CO., INC.  
 10 NO LEE • OKLA. CITY, OKLA. 73102

a winning pair...the  
**"Kenwood  
 twins"**



THE MOST EXCITING RECEIVER AND TRANSMITTER TO ENTER THE AMATEUR SCENE IN RECENT YEARS. THE KENWOOD R-599 SOLID STATE RECEIVER AND T-599 HYBRID TRANSMITTER HAVE ESTABLISHED NEW STANDARDS OF PERFORMANCE, RELIABILITY, FLEXIBILITY, STYLING AND VALUE.

**THE R-599 RECEIVER:** .5 microvolt sensitivity (amateur bands 1.8-21.0 MHz) • Dial readout to 1/2 kilocycle • Special detectors for SSB, AM, and FM • Transceive operation with T-599 • Built-in 100 kc and 25 kc crystal calibrator • Built-in 500 cycle CW filter • Provision for two meter and six meter coverage with optional accessory self-contained converters • Advanced "Space-Age" styling • Adjustable threshold squelch • Only \$349.00 • S599 Speaker \$16.00

**THE T-599 TRANSMITTER:** Clear, stable, selectable side-band, AM and CW • 4-way VFO Flexibility plus Receiver Incremental Tuning (RIT) when used with the R-599 • Amplified ALC • Built-in VOX • Full metering, including cathode current, plate voltage, ALC and relative Power Output • Built-in CW Sidetone monitor and semi-automatic break-in CW • Built-in power supply • Maximum TVI protection • Employs only 3 vacuum tubes • Only \$395.00

THE KENWOOD  
**TS-511S**  
 TRANSCEIVER

The Kenwood TS-511S is a five band SSB and CW transceiver packed with power and performance... offering features never before available in its price range. For example: built-in VOX, crystal calibrator, noise blanker, receiver incremental tuning, 1 kHz frequency readout, 8 pole filter, stable FET VFO, dual conversion and accessory CW filter.



**FREQUENCY RANGE:** 10, 15, 20, 40 & 80 meters (Amateur Bands)  
 MODES: LSB, USB, CW  
 INPUT POWER: 500 watts PEP, 300 watts CW nominal.  
 SENSITIVITY: 3.5-21.6 mHz band; 0.5 uv S/N 10 db 28.0-29.7 mHz band; 1.5 uv S/N 10 db and less than 100 cps frequency drift per 30 minutes after warm-up  
 SELECTIVITY: SSB more than 2.4

KC (at 6 db) with 2 to 1 slope ratio  
 CW more than 0.5 KC (at 6 db)  
 A.F. OUTPUT: more than 1 watt (10% distortion)  
 TUBE & SOLID STATE COMPONENTS: 10 Tubes, 1 IC, 37 Transistors, 4 FET, 52 Diodes  
 PRICE: \$415.00

PS 511S • Power Supply with built-in speaker \$105.00  
 CW-1 Filter \$39.00  
 VFO 5SS \$105.00

11240 W. Olympic Blvd. Los Angeles, Calif. 90064 213/477 6701  
 931 N. Euclid, Anaheim, Calif. 92801 714/772 9200  
 Butler, Missouri 64730 816/679 3127

**Henry Radio**

# 2500 kW output

**Now—only two tubes are required in the power amplifier stage of a 2500 kW, 100% modulated long, medium or shortwave broadcast transmitter**

Shown below are two EIMAC X-2159 developmental tetrodes, the most powerful tubes in the world. A single X-2159 has an anode dissipation of 1250 kW. Two tubes provide a carrier power of 2500 kW, 100% amplitude modulated.

Here is a technological breakthrough permitting a very high power broadcast transmitter to be built, having a single output stage. Now, for the first time, 5 megawatts output, or greater, is practical. Substantially less capital investment is required; driver stages, power supplies, control circuits, cabinets, and floor space may be substantially reduced when these high gain tetrode tubes are employed.

For full specifications on the new EIMAC X-2159 contact any of the more than 30 Varian/EIMAC Electron Tube and Device Group sales offices throughout the world.

Or the EIMAC Division of Varian  
301 Industrial Way, San Carlos, California 94070.



4CX5000A  
Shown for  
size comparison.